

AZ DISPLAYS

SPECIFICATIONS FOR LIQUID CRYSTAL DISPLAY

CUSTOMER APPROVAL			
※ PART NO.: <u>AQM1212K-FLW-FBH (AZ DISPLAYS) VER1.0</u>			
APPROVAL		COMPANY CHOP	
CUSTOMER COMMENTS			

AZ DISPLAYS ENGINEERING APPROVAL		
DESIGNED BY	CHECKED BY	APPROVED BY
CXR		

REVISION RECORD

REVISION	REVISION DATE	PAGE	CONTENTS
VER1.0	2016-08-10		FIRST ISSUE

※ CONTENTS

- 1.0 GENERAL SPECS
- 2.0 ABSOLUTE MAXIMUM RATINGS
- 3.0 ELECTRICAL CHARACTERISTICS
- 4.0 OPTICAL CHARACTERISTICS
- 5.0 BLOCK DIAGRAM
- 6.0 PIN ASSIGNMENT
- 7.0 POWER SUPPLY
- 8.0 TIMING CHARACTERISTICS
- 9.0 MECHANICAL DIAGRAM
- 10.0 RELIABILITY TEST
- 11.0 DISPLAY INSTRUCTION TABLE
- 12.0 APPEARANCE CRITERIA
- 13.0 PRECAUTION FOR USING LCM

1.0 GENERAL SPECS

1. Display Format	128*128 Character
2. Power Supply	3.0V(Single power supply without DC-DC,adjustable Vop)
3. Module outline dimension	76.04mm(W) x 77.34mm(H) x max 10.07mm(D)
1. Viewing Area(W*H)	58.48mm(W) x 58.48mm(H)
2. Dot Size (W*H)	0.38mm(W) x 0.38mm(H)
3. Dot Pitch (W*H)	0.41mm(W) x 0.41mm(H)
4. Viewing Direction	6:00 O'Clock
5. Driving Method	1/128Duty,1/12Bias
6. Control IC	ST7541
7. Display Mode	FSTN/Positive/Transflective, UV BLOCKING
8. Backlight	WHITE LED/SIDE
9. Operating temperature	-20°C ~ 70°C
10. Storage temperature	-30°C ~ 80°C
11. ROHS	ROHS compliant

2.0 ABSOLUTE MAXIMUM RATINGS

Item	Symbol	Min	Typ	Max	Unit
Operating temperature	Top	-20	--	70	°C
Storage temperature	Tst	-30	--	80	°C
Input voltage	Vin	-0.5	--	Vdd+0.5	V
Supply voltage for logic	Vdd- Vss	-0.3	--	3.6	V
Supply voltage for LCD drive	VOUT_IN	-0.5	--	20	V

3.0 ELECTRICAL CHARACTERISTICS

3.1 Electrical Characteristics Of LCM

Item	Symbol	Condition	Min	Typ	Max	Unit
Power Supply Voltage	VDD	Ta=25°C	2.9	3.0	3.1	V
Power Supply Current	Idd	Vdd=3.0V	--	--	--	mA
Input voltage (high)	Vih	H level	0.7Vdd	-	Vdd	V
Input voltage (low)	Vil	L level	VSS	-	0.3VSS	V
Recommended LC Driving Voltage	Vdd -Vo	-20°C	-			V
		25°C	12.3	12.5	12.7	
		70°C			-	

3.2 The Characteristics Of LED Backlight

3.2.1 Electrical-Optical Characteristics Of LED Backlight (Ta=25°C)

Item	Symbol	Condition	Min	Typ	Max	Unit
Forward Voltage ⁽¹⁾	Vf	If=30mA	6.8	7.0	7.2	V
Reverse Voltage	Vr		--	5.0	--	V
Luminance ⁽²⁾	Lv	If=30mA	--	--	--	cd/m ²
Uniformity ⁽³⁾	Δ	(Lvmin/Lvmax)%	75%	--	--	--
Lifetime ⁽⁴⁾		If=30mA	--	20000	---	Hours

NOTE: Luminance means the backlight brightness without glass

(1) Forward voltage means voltage applied directly to the LED, please refer to the backlight diagram.

(2) The luminance is the average value of 5 points, The measurement instrument is BM-7 luminance colorimeter. The diameter of aperture is Φ5mm

(3) Luminance means the backlight brightness without LCD.

(4) Backlight lifetime means luminance value larger than half of the original after 20000 hours' continuous working.

3.2.2 Backlight Control Circuit FOR LCM (2X2=4 pcs LED)

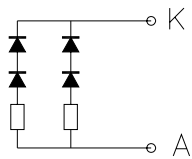

3.2.3 LED Typical Electro-Optical Characteristics Curve (For single LED) :

1. Forward current vs. Ambient temperature

2. Forward current vs. Forward voltage

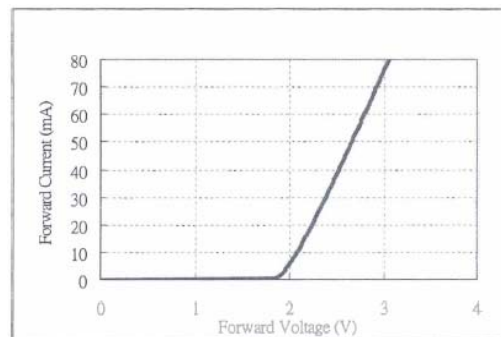
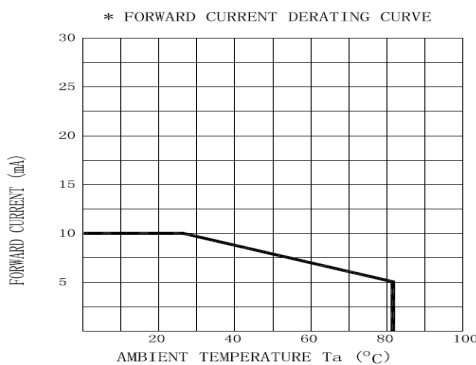

4.0 OPTICAL CHARACTERISTICS (Ta=25°C, Vdd= 5.0V±0.25V)

Item	Symbol	Condition	Min	Typ	Max	Unit
Viewing angle (horizontal)	$\theta 1$	--	30	-	--	deg
Viewing angle (horizontal)	$\theta 2$	--	45	-	--	deg
Viewing angle (vertical)	$\phi 1$	--	45	--	--	deg
Viewing angle (vertical)	$\phi 2$	--	45	--	--	deg
Contrast Ratio	Cr	Ta=23±3° VLCD=Typ	--	T.B.D.	-	--
Response time (rise)	Tr	$\phi=0^\circ, \theta=0^\circ$	-	250	300	ms
Response time (fall)	Tf	$\phi=0^\circ, \theta=0^\circ$	-	200	250	ms

(1). Definition of Optical Response Time

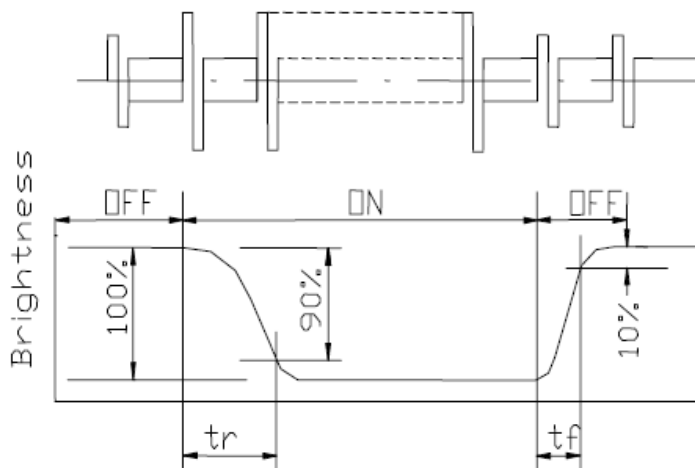

(2). Definition of Contrast Ratio

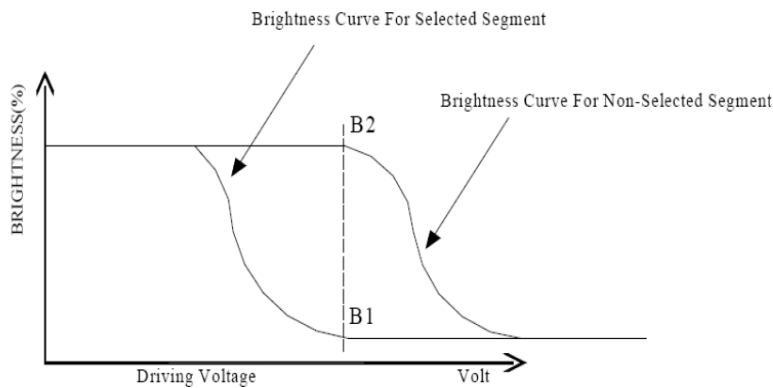

$$Cr = \frac{\text{Brightness of Non-selected Segment}(B2)}{\text{Brightness of selected Segment}(B1)}$$

(3). Definition of Viewing Angle θ 1 and θ 2

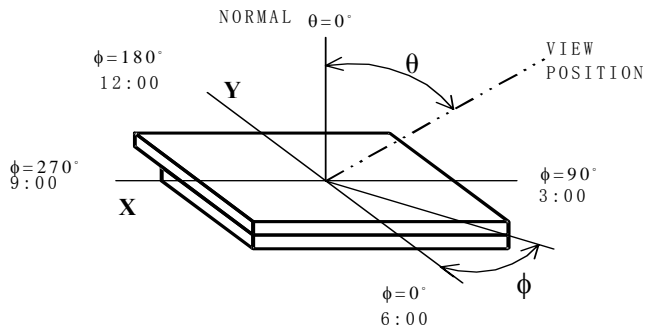

5.0 BLOCK DIAGRAM

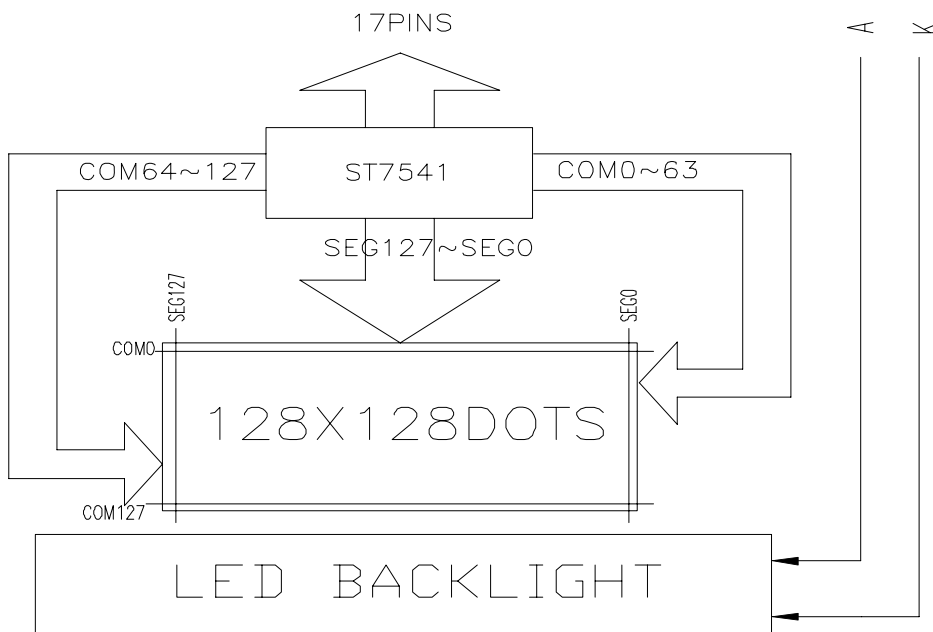

6.0 PIN ASSIGNMENT

Pin No.	Symbol	Description	Level
1	CSB	Chip select input pins	L->data/instruction I/O is enabled non-active->DB0 to DB7 may be high impedance
2	RST	Reset input pin	RESETB is L->reset
3	A0	Register select input pin	H/L
4	WR_RW	READ_WRITE(6800 INTERFACE)	H/L
5	E_RD	ENABLE(6800 INTERFACE)	H/L
6	D0	Data bit 0	H/L
7	D1	Data bit 1	H/L
8	D2	Data bit 2	H/L
9	D3	Data bit 3	H/L
10	D4	Data bit 4	H/L
11	D5	Data bit 5	H/L
12	D6	Data bit 6	H/L
13	D7	Data bit 7	H/L
14	VDD	Logic Power supply	--
15	VSS	Ground	--
16	VOUT	LCD power supply pin	--
17	VSS	Ground	--

7.0 POWER SUPPLY

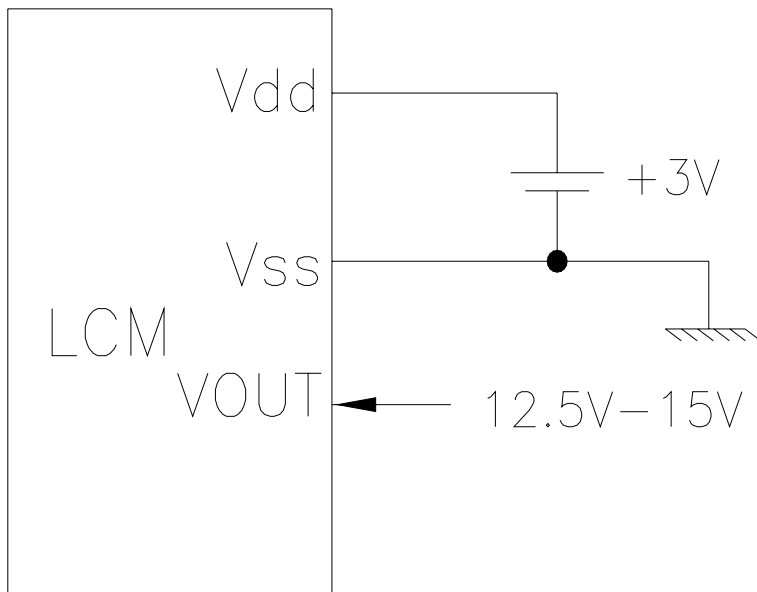

8.0 TIMING CHARACTERISTICS

System Bus Read/Write Characteristics 1 (For the 6800 Series MPU)

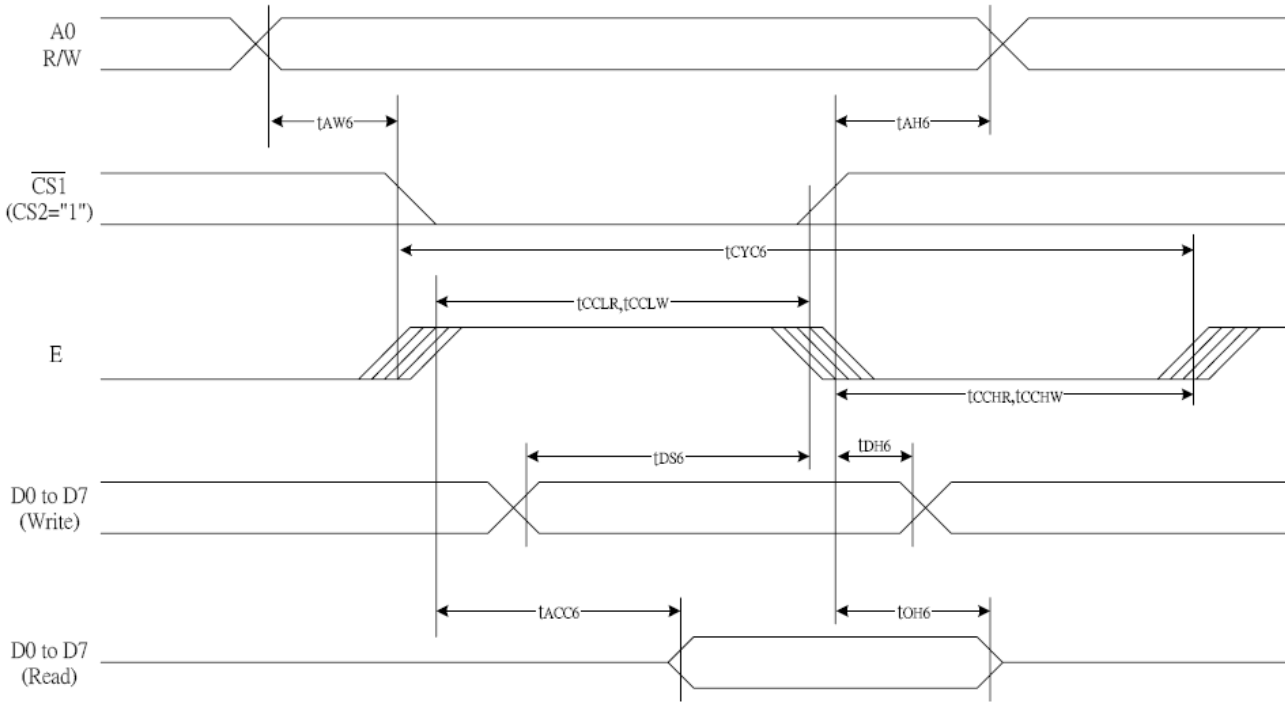

(VDD = 3.3 V , Ta = -30~85°C)

Item	Signal	Symbol	Condition	Rating		Units
				Min.	Max.	
Address hold time	A0	tAH6		0	—	ns
Address setup time		tAW6		0	—	
System cycle time		tCYC6		240	—	
Enable L pulse width (WRITE)	WR	tEWLW		80	—	
Enable H pulse width (WRITE)		tEWHW		80	—	
Enable L pulse width (READ)	RD	tEWLR		80	—	
Enable H pulse width (READ)		tEWHR		140	—	
WRITE Data setup time	D0 to D7	tDS6		40	—	
WRITE Data hold time		tDH6		10	—	
READ access time		tACC6	CL = 100 pF	—	70	
READ Output disable time		tOH6	CL = 100 pF	5	50	

AQM1212K-FLW-FBH (AZ DISPLAYS) CHARACTER MODULE VER1.0

(VDD = 2.7V , Ta = -30~85°C)

Item	Signal	Symbol	Condition	Rating		Units
				Min.	Max.	
Address hold time	A0	tAH6		0	—	ns
Address setup time		tAW6		0	—	
System cycle time		tCYC6		400	—	
Enable L pulse width (WRITE)	WR	tEWLW		220	—	
Enable H pulse width (WRITE)		tEWHW		180	—	
Enable L pulse width (READ)	RD	tEWLR		220	—	
Enable H pulse width (READ)		tEWHR		180	—	
WRITE Data setup time	D0 to D7	tDS6		40	—	
WRITE Data hold time		tDH6		15	—	
READ access time		tACC6	CL = 100 pF	—	140	
READ Output disable time		tOH6	CL = 100 pF	10	100	

(VDD = 1.8V , Ta = -30~85°C)

Item	Signal	Symbol	Condition	Rating		Units
				Min.	Max.	
Address hold time	A0	tAH6		0	—	ns
Address setup time		tAW6		0	—	
System cycle time		tCYC6		640	—	
Enable L pulse width (WRITE)	WR	tEWLW		360	—	
Enable H pulse width (WRITE)		tEWHW		280	—	
Enable L pulse width (READ)	RD	tEWLR		360	—	
Enable H pulse width (READ)		tEWHR		280	—	
WRITE Data setup time	D0 to D7	tDS6		80	—	
WRITE Data hold time		tDH6		30	—	
READ access time		tACC6	CL = 100 pF	—	240	
READ Output disable time		tOH6	CL = 100 pF	10	200	

*1 The input signal rise time and fall time (tr, tf) is specified at 15 ns or less. When the system cycle time is extremely fast, (tr + tf) ≤ (tCYC6 – tEWLW – tEWHW) for (tr + tf) ≤ (tCYC6 – tEWLR – tEWHR) are specified.

*2 All timing is specified using 20% and 80% of VDD as the reference.

*3 tEWLW and tEWLR are specified as the overlap between CSB being "L" and E.

9.0 MECHANICAL DIAGRAM

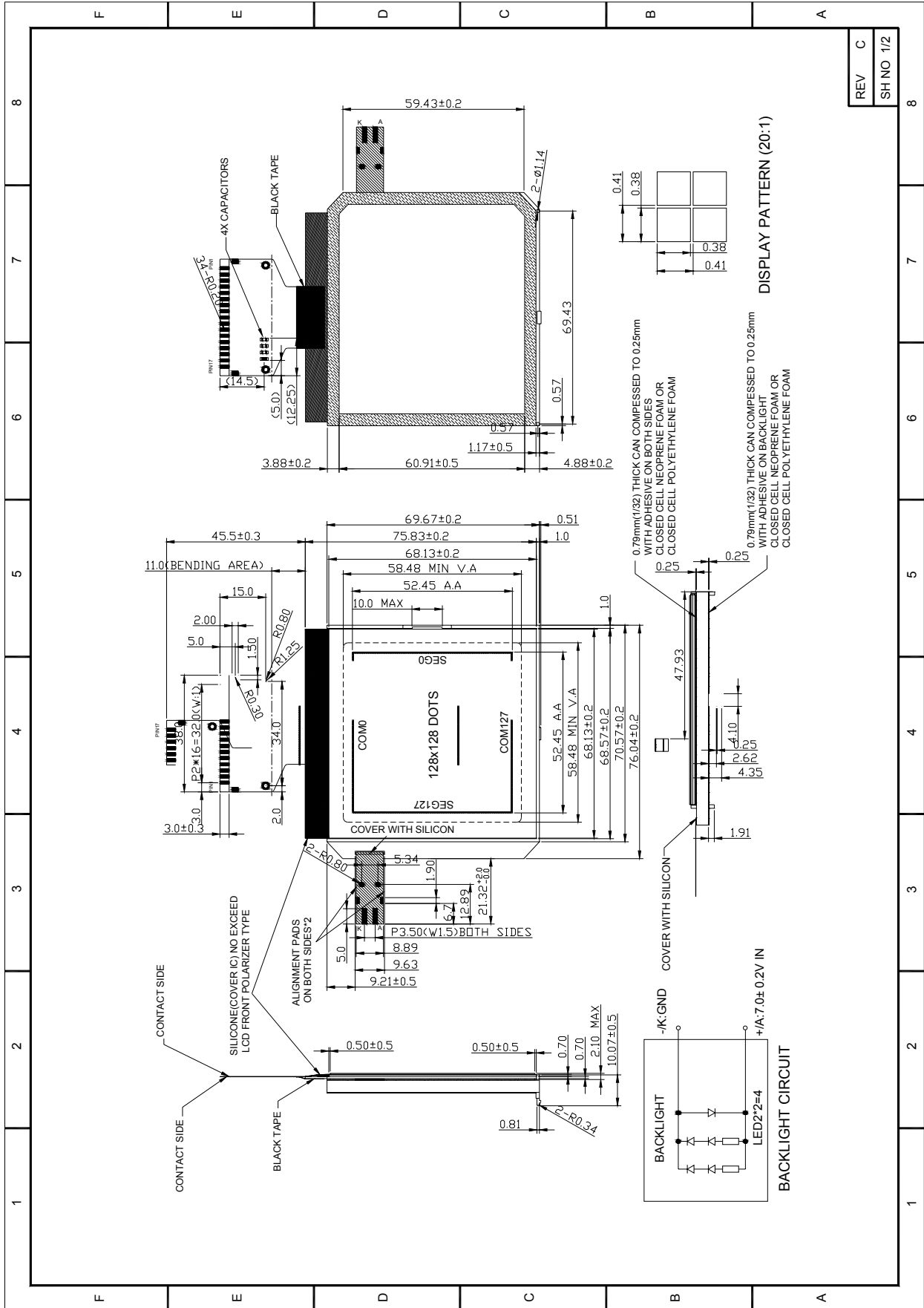

AQM1212K-FLW-FBH (AZ DISPLAYS) CHARACTER MODULE VER1.0

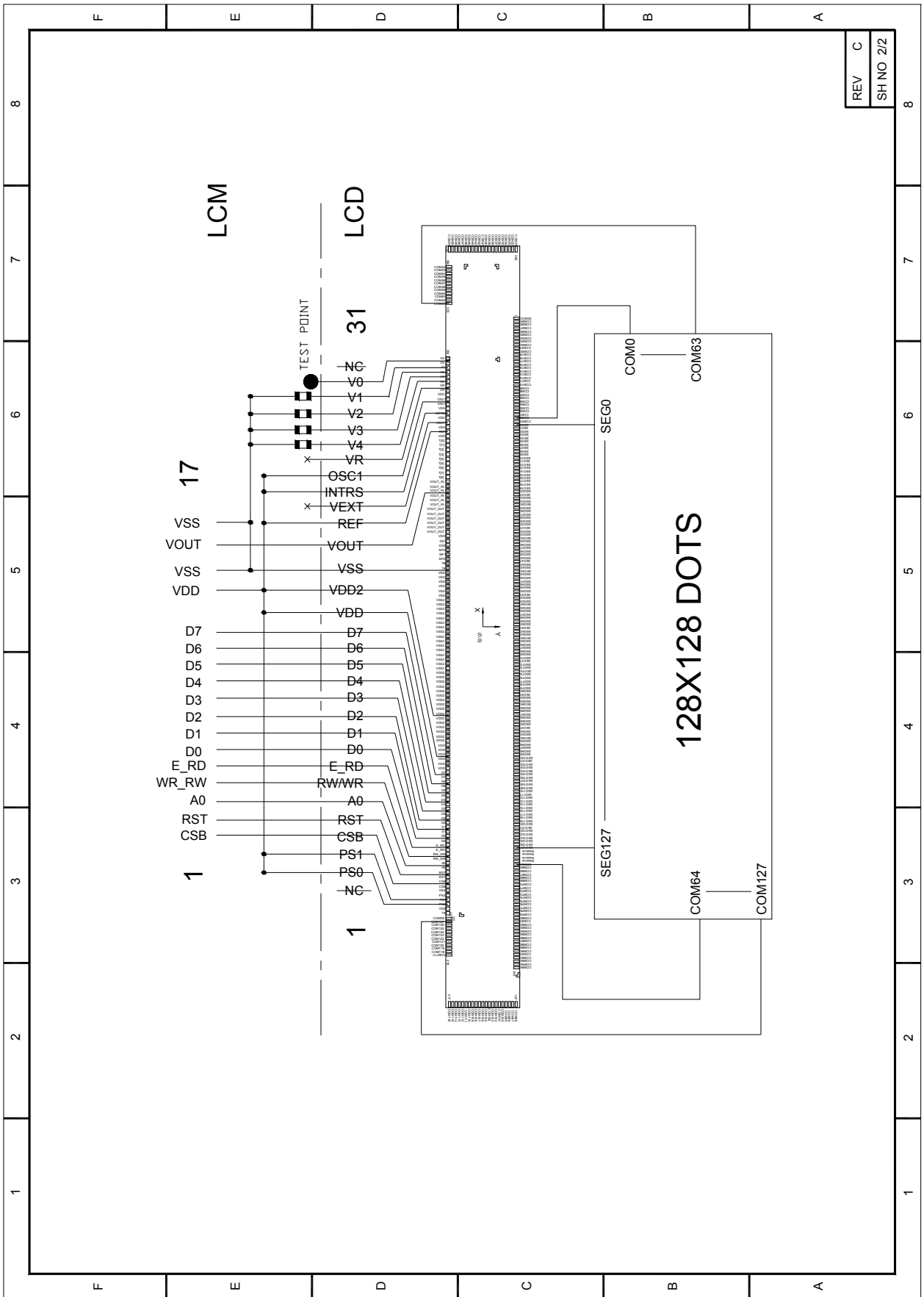

10.0 RELIABILITY TEST

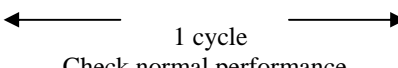
NO	Test Item	Description	Test Condition	Remark	
1	Environmental Test	High temperature/High Humidity Storage	Applying the high storage temperature Under high humidity for a long time Check normal performance	90% RH 40°C 96hrs	
2		High temperature storage	Applying the low storage temperature Under normal humidity for a long time Check normal performance	80°C 96hrs	
3		Low temperature storage	Applying the low storage temperature Under normal humidity for a long time Check normal performance	-30°C 96hrs	
4		High temperature Operation	Apply the electric stress(Voltage and current) Under high temperature for a long time	≤30% RH 70°C 120hrs	Note1
5		Low temperature Operation	Apply the electric stress Under low temperature for a long time	-20°C 96hrs	Note1 Note2
6		Temperature Cycle	Apply the low and high temperature cycle -30°C <> 25°C <> 80°C <> 25°C 30min 10min 30min 10min  1 cycle Check normal performance	-30°C/80°C 10 cycle	
7	Mechanical Test	Vibration test(Package state)	Applying vibration to product check normal performance	Freq:10-55Hz Max Acceleration 5G 1cycle time:1min time X.Y.Z direction for 15 mins	
8		Shock test(package state)	Applying shock to product check normal performance	Drop them through 70cm height to strike horizontal plane	
9	Other				

Remark

Note1:Normal operations condition (25°C±5°C).

Note2:Pay attention to keep dewdrops from the module during this test.

11.0 DISPLAY INSTRUCTION TaBle

The display control instructions control the internal state of the ST7541. Instructions are received from MPU to ST7541 for the display control.

Instruction	A0	RW	DB7	DB6	DB5	DB4	DB3	DB2	DB1	DB0	Description
Mode Set	0	0	0	0	1	1	1	0	0	0	2-byte instruction to set Mode and FR(Frame frequency control) BE(Booster efficiency control)
	0	0	FR3	FR2	FR1	FR0	0	BE	x'	0	
Read display data	1	1	Read data								Read data into DDRAM
Write display data	1	0	Write data								Write data into DDRAM
Read status	0	1	BUSY	ON	RES	MF2	MF1	MF0	DS1	DS0	Read the internal status
ICON control register ON/OFF	0	0	1	0	1	0	0	0	1	ICON	ICON=0: ICON disable(default) ICON=1: ICON enable & set the page address to 16
Set page address	0	0	1	0	1	1	P3	P2	P1	P0	Set page address
Set column address MSB	0	0	0	0	0	1	0	Y7	Y6	Y5	Set column address MSB
Set column address LSB	0	0	0	0	0	0	Y4	Y3	Y2	Y1	Set column address LSB
Set modify-read	0	0	1	1	1	0	0	0	0	0	Set modify-read mode
Reset modify-read	0	0	1	1	1	0	1	1	1	0	release modify-read mode
Display ON/OFF	0	0	1	0	1	0	1	1	1	D	D=0: Display OFF D=1: Display ON
Set initial display line register	0	0	0	1	0	0	0	0	x'	x'	2-byte instruction to specify the initial display line to realize vertical scrolling
	0	0	x'	S6	S5	S4	S3	S2	S1	S0	
Set initial COM0 register	0	0	0	1	0	0	0	1	x'	x'	2-byte instruction to specify the initial COM0 to realize window scrolling
	0	0	x'	C6	C5	C4	C3	C2	C1	C0	
Set partial display duty ration	0	0	0	1	0	0	1	0	x'	x'	2-byte instruction to set partial display duty ratio
	0	0	D7	D6	D5	D4	D3	D2	D1	D0	
Set N-line inversion	0	0	0	1	0	0	1	1	x'	x'	2-byte instruction to set N-line inversion register
	0	0	x'	x'	x'	N4	N3	N2	N1	N0	
Release N-line inversion	0	0	1	1	1	0	0	1	0	0	Release N-line inversion mode
Reverse display ON/OFF	0	0	1	0	1	0	0	1	1	REV	REV=0: normal display REV=1: reverse display
Entire display ON/OFF	0	0	1	0	1	0	0	1	0	EON	EON=0: normal display EON=1: entire display ON



AQM1212K-FLW-FBH (AZ DISPLAYS) CHARACTER MODULE VER1.0

Instruction	A0	R/W	DB7	DB6	DB5	DB4	DB3	DB2	DB1	DB0	Description
Power Control	0	0	0	0	1	0	1	VC	VR	VF	Set power circuits ON/OFF
Select DC-DC step-up	0	0	0	1	1	0	0	1	DC1	DC0	Select built-in booster step
Select Regulator Register	0	0	0	0	1	0	0	R2	R1	R0	Select the internal resistance ratio of the regulator resistor
Select Electronic Volume	0	0	1	0	0	0	0	0	0	1	2-byte command
	0	0	x'	x'	EV5	EV4	EV3	EV2	EV1	EV0	Adjust contrast level
Select LCD bias	0	0	0	1	0	1	0	B2	B1	B0	Select LCD bias
High Power Mode	0	0	1	1	1	1	0	1	1	1	2-byte command
	0	0	0	0	0	1	1	0	1	0	Enable High Power Mode
High Power Mode Control	0	0	1	1	1	1	0	0	1	1	2-byte command
	0	0	0	0	0	0	1	1	0	1	Controls high driving mode
SHL select	0	0	1	1	0	0	SHL	x'	x'	x'	COM bi-directional selection SHL=0: normal direction SHL=1: reverse direction
ADC select	0	0	1	0	1	0	0	0	0	ADC	SEG bi-direction selection ADC=0: normal direction ADC=1: reverse direction
Oscillator ON	0	0	1	0	1	0	1	0	1	1	Start the built-in oscillator
Set power save mode	0	0	1	0	1	0	1	0	0	P	P=0: normal mode P=1: sleep mode
Release power save mode	0	0	1	1	1	0	0	0	0	1	Release power save mode
RESET	0	0	1	1	1	0	0	0	1	0	Software reset Refer to RESET CIRCUIT
Set display data length (DDL)	x'	x'	1	1	1	0	1	0	0	0	2-byte command
	x'	x'	D7	D6	D5	D4	D3	D2	D1	D0	Specify the number of data bytes. (3-Line SPI only)
Set FRC/PWM mode	0	0	1	0	0	1	0	FRC	PWM1	PWM0	FRC: 1=3FRC, 0=4FRC PWM[1:0]: (0,0)=(0,1)=9PWM (1,0)=12PWM (1,1)=15PWM
NOP	0	0	1	1	1	0	0	0	1	1	No operation
Test Instruction	0	0	1	1	1	1	x'	x'	x'	x'	Don't use this instruction

AQM1212K-FLW-FBH (AZ DISPLAYS) CHARACTER MODULE VER1.0

Instruction	A0	RW	DB7	DB6	DB5	DB4	DB3	DB2	DB1	DB0	Description
Set white mode and 1 st /2 nd frame, set pulse width	0	0	1	0	0	0	1	0	0	0	Set white mode and 1 st /2 nd frame
	0	0	WB3	WB2	WB1	WB0	WA3	WA2	WA1	WA0	
Set white mode and 3 rd /4 th frame, set pulse width	0	0	1	0	0	0	1	0	0	1	Set white mode and 3 rd /4 th frame
	0	0	WD3	WD2	WD1	WD0	WC3	WC2	WC1	WC0	
Set light gray mode and 1 st /2 nd frame, set pulse width	0	0	1	0	0	0	1	0	1	0	Set light gray mode and 1 st /2 nd frame
	0	0	LB3	LB2	LB1	LB0	LA3	LA2	LA1	LA0	
Set light gray mode and 3 rd /4 th frame, set pulse width	0	0	1	0	0	0	1	0	1	1	Set light gray mode and 3 rd /4 th frame
	0	0	LD3	LD2	LD1	LD0	LC3	LC2	LC1	LC0	
Set dark gray mode and 1 st /2 nd frame, set pulse width	0	0	1	0	0	0	1	1	0	0	Set dark gray mode and 1 st /2 nd frame
	0	0	DB3	DB2	DB1	DB0	DA3	DA2	DA1	DA0	
Set dark gray mode and 3 rd /4 th frame, set pulse width	0	0	1	0	0	0	1	1	0	1	Set dark gray mode and 3 rd /4 th frame
	0	0	DD3	DD2	DD1	DD0	DC3	DC2	DC1	DC0	
Set dark mode and 1 st /2 nd frame, set pulse width	0	0	1	0	0	0	1	1	1	0	Set dark mode and 1 st /2 nd frame
	0	0	BB3	BB2	BB1	BB0	BA3	BA2	BA1	BA0	
Set dark mode and 3 rd /4 th frame, set pulse width	0	0	1	0	0	0	1	1	1	1	Set white mode and 3 rd /4 th frame
	0	0	BB3	BD2	BD1	BD0	BC3	BC2	BC1	BC0	

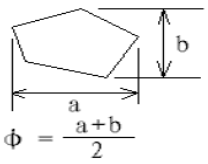
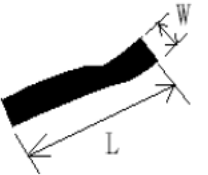
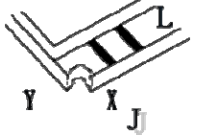
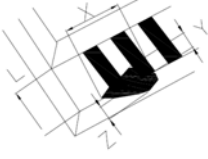
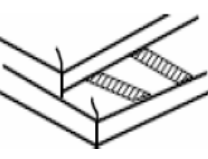
12.0 APPEARANCE CRITERIA

Item	Description	Picture	Specification			MA	MI	Inspection Method
Dot defects (black/white dot)	Scratches black dot white dot on the polarizer dirty spot and bubble between the polarizer and glass in the display area.	 <p>J:the distance between dot and dot.</p>	≤ 0.1	Ignored		●		Visual/contrast by Inspection standard film
			$0.1 < \phi \leq 0.20$	2	J > 5			
			$0.20 < \phi \leq 0.25$	1	J > 10			
			$0.25 < \phi \leq 0.30$	0				
			$0\phi > 0.3$	0				
black/white line defect (straight line or curve etc. Line type defects)	Fibres in active area, scratches and black line on the glass or polarizer.	 <p>J:the distance between dot and dot.</p>	$W \leq 0.01$	Ignored		●		Visual/contrast by Inspection standard film
			$W \leq 0.02 \quad L \leq 5$	2	J > 5			
			$W \leq 0.03 \quad L \leq 4$	1	J > 10			
			$W \leq 0.04 \quad L \leq 3$	0	J > 10			
			$W \leq 0.05 \quad L \leq 2$	0				
Chip on corner	sidestep on the lower glass	 <p>Y:width of chip X:length of chip L:width of sidestep J:distance between electrode and the farthermost edge.</p>	$Y \leq 1/2L, X \leq 1$	Ignored		●		Visual/contrast by Inspection standard film
			$Y \leq 1/2L, X \leq 2$	2				
			$Y \leq 1/2L, X \leq 3$	1				
			$Y \leq 1/2L, X \leq 1/3J$	0	J ≤ 3			
			$Y \leq 1/2L, X \leq 2/3J$	0	J ≤ 3			
Crack		 <p>Y:width of crack X:length of crack L:width of sidestep T:depth of crack Z:thickness of single glass</p>	$Y \leq 1/5L \quad X \leq 5 \quad Z \leq 1/2T$	Ignored		●		Visual/contrast by Inspection standard film
			$Y \leq 1/4L \quad X \leq 5 \quad Z \leq 1/2T$	2				
			$Y \leq 1/3L \quad X \leq 5 \quad Z \leq 1/2T$	1				
			$Y \leq 1/3L \quad X \leq 10 \quad Z \leq 1/2T$	0				
			$Y \leq 1/3L \quad X \leq 15 \quad Z \leq 1/2T$	0				
Crack			Cracks in any area	rejected		●		Visual
Polarizer			≤ 0.8	Accepted		●		Visual/

AQM1212K-FLW-FBH (AZ DISPLAYS) CHARACTER MODULE VER1.0

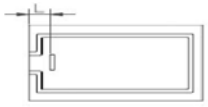
		be applicable for up/bottom polarizer	0.8<L≤1.0	Rejected			contrast by Inspection standard film
			1.0<L≤1.5	Rejected			
			1.5<L≤2.0	Rejected			
			Any seeable polarizer slanting or excursion in active area will be rejected. The polarizer edge should be even and be line. Any indentation within 1/3 of silkscreen line will be rejected. Wrong direction, missing or extra, incorrect sticking for polarizer and dirty surface(grease) on polarizer will be rejected. seeable black silkscreen line from the arond can be accepted. Refer to the drawing size requirement.				
End seal		 <p>L:The distance from the block to edge of glass.</p>	UV glue of seal on the glass surface	Rejected	●		Visual/contrast by Inspection standard film
			The UV glue of seal overflow into the active area.	Rejected			
			Direction of end seal is different from the drawing.	Rejected			
			Glue capacity of end seal < (1/3)*L	Rejected			
			the height and length of end seal is out of the drawing requirements.	Rejected			
Silkscreen line			silkscreen line overflow into the active area.	Rejected	●		Visual/contrast by Inspection standard film
			silkscreen line deviated in active area.	Rejected			
			bubble of silkscreen line ≥ 1/3 width of silkscreen line	Rejected			

AQM1212K-FLW-FBH (AZ DISPLAYS) CHARACTER MODULE VER1.0

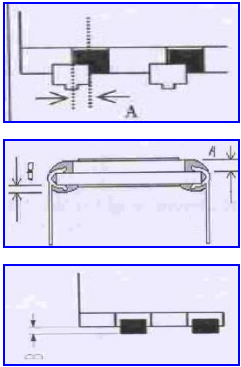
PIN			<p>Glue on PIN: there is glue on the PIN without pin clip will be rejected. PIN glue solidification: PIN glue doesn't solidify completely. The sunken or glue stain by touching will be rejected.</p> <p>PIN deflection: if deflection angle $> \pm 5^\circ$, rejected; contrarily, please refer to the drawing requirement. Without continuous glue on pins will be rejected.</p> <p>PIN glue stains on polarizer or inleakage polarizer and glass, rejected.</p> <p>PIN glue exceeds the up polarizer, rejected.</p> <p>Missing or extra, broken pin, rejected.</p> <p>PIN loosen: no permission for pin loose or drop.</p> <p>Clip PIN:pin center exceeds 1/3 ITO width, rejected.</p> <p>No pin glue, rejected.</p> <p>UV glue range: UV glue must be exceeded over 1~1.5 pin distance from both side. if not, rejected.</p> <p>PIN length and direction must be same with the drawing requirements.</p>		●	Visual/contrast by Inspection standard film	
Protective film			<p>LCD protective film can not stick on the polarizer and the product protective film raised $\leq 1/3$ length or width of polarizer from same direction of axis and its total length should be $\leq 15\text{mm}$. This defect can be accepted.</p>		●	Visual	
Rainbow			rainbow is not in active area.	Accepted		Visual/contrast by golden sample	
			Rainbow in active area.	Rejected	●		
			with obvious discoloration and uneven color.	Rejected			
background color			There are obvious different background color from the same product lot.	Rejected		●	Visual/contrast by golden sample

NOTE:

Inspection condition:

Viewing distance for cosmetic inspection is 30cm with bare eyes, and under an environment of 800 lux(20W*2---40W) light intensity, all directions for inspecting the sample should be within 45° against perpendicular

13.0 PRECAUTION FOR USING LCM

1. When design the product with this LCD Module, make sure the viewing angle matches to its purpose of usage.
2. As LCD panel is made of glass substrate, Dropping the LCD module or banging it against hard objects may cause cracking or fragmentation. Especially at corners and edges.
3. Although the polarizer of this LCD Module has the anti-glare coating, always be careful not to scratch its surface. Use of a plastic cover is recommended to protect the surface of polarizer.
4. If the LCD module is stored at below specified temperature, the LC material may freeze and be deteriorated. If it is stored at above specified temperature, the molecular orientation of the LC material may change to Liquid state and it may not revert to its original state. Excessive temperature and humidity could cause polarizer peel off or bubble. Therefore, the LCD module should always be stored within specified temperature range.
5. Saliva or water droplets must be wiped off immediately as those may leave stains or cause color changes if remained for a long time. Water vapor will cause corrosion of ITO electrodes.
6. If the surface of LCD panel needs to be cleaned, wipe it swiftly with cotton or other soft cloth. If it is not still clean enough, blow a breath on the surface and wipe again.
7. The module should be driven according to the specified ratings to avoid malfunction and permanent damage. Applying DC voltage cause a rapid deterioration of LC material. Make sure to apply alternating waveform by continuous application of the M signal. Especially the power ON/OFF sequence should be kept to avoid latch-up of driver LSIs and DC charge up to LCD panel.
8. Mechanical Considerations
 - a) LCM are assembled and adjusted with a high degree of precision. Avoid excessive shocks and do not make any alterations or modifications. The following should be noted.
 - b) Do not tamper in any way with the tabs on the metal frame.
 - c) Do not modify the PCB by drilling extra holes, changing its outline, moving its components or modifying its pattern.
 - d) Do not touch the elastomer connector; especially insert a backlight panel (for example, EL).
 - e) When mounting a LCM makes sure that the PCB is not under any stress such as bending or twisting. Elastomer contacts are very delicate and missing pixels could result from slight dislocation of any of the elements.
 - f) Avoid pressing on the metal bezel, otherwise the elastomer connector could be deformed and lose contact, resulting in missing pixels.
9. Static Electricity
 - a) Operator

Wear the electrostatics shielded clothes because human body may be statically charged if not wear shielded clothes. Never touch any of the conductive parts such as the LSI pads; the copper leads on the PCB and the interface terminals with any parts of the human body.

b) Equipment

There is a possibility that the static electricity is charged to the equipment, which has a function of peeling or friction action (ex: conveyer, soldering iron, working table). Earth the equipment through proper resistance (electrostatic earth: 1×10^8 ohm).

Only properly grounded soldering irons should be used.

If an electric screwdriver is used, it should be well grounded and shielded from commutator sparks.

The normal static prevention measures should be observed for work clothes and working benches; for the latter conductive (rubber) mat is recommended.

c) Floor

Floor is the important part to drain static electricity, which is generated by operators or equipment.

There is a possibility that charged static electricity is not properly drained in case of insulating floor. Set the electrostatic earth (electrostatic earth: 1×10^8 ohm).

d) Humidity

Proper humidity helps in reducing the chance of generating electrostatic charges. Humidity should be kept over 50%RH.

e) Transportation/storage

The storage materials also need to be anti-static treated because there is a possibility that the human body or storage materials such as containers may be statically charged by friction or peeling.

The modules should be kept in antistatic bags or other containers resistant to static for storage.

f) Soldering

Solder only to the I/O terminals. Use only soldering irons with proper grounding and no leakage.

Soldering temperature : $280^{\circ} \text{C} \pm 10^{\circ} \text{C}$

Soldering time: 3 to 4 sec.

Use eutectic solder with resin flux fill.

If flux is used, the LCD surface should be covered to avoid flux spatters. Flux residue should be removed afterwards.

g) Others

The laminator (protective film) is attached on the surface of LCD panel to prevent it from scratches or stains. It should be peeled off slowly using static eliminator.

Static eliminator should also be installed to the workbench to prevent LCD module from static charge.

10. Operation

- a) Driving voltage should be kept within specified range; excess voltage shortens display life.
 - b) Response time increases with decrease in temperature.
 - c) Display may turn black or dark blue at temperatures above its operational range; this is (however not pressing on the viewing area) may cause the segments to appear "fractured".
 - d) Mechanical disturbance during operation (such as pressing on the viewing area) may cause the segments to appear "fractured".
11. If any fluid leaks out of a damaged glass cell, wash off any human part that comes into contact with soap and water. The toxicity is extremely low but caution should be exercised at all the time.
 12. Disassembling the LCD module can cause permanent damage and it should be strictly avoided.
 13. LCD retains the display pattern when it is applied for long time (Image retention). To prevent image retention, do not apply the fixed pattern for a long time. Image retention is not a deterioration of LCD. It will be removed after display pattern is changed.
 14. Do not use any materials, which emit gas from epoxy resin (hardener for amine) and silicone adhesive agent (dealcohol or deoxym) to prevent discoloration of polarizer due to gas.
 15. Avoid the exposure of the module to the direct sunlight or strong ultraviolet light for a long time.