

SHARP

No.	LD – 19Z56A
DATE	DEC. 10. 2007

Rev.

TECHNICAL LITERATURE
FOR
TFT - LCD module

These parts have corresponded with the RoHS directive.

MODEL No. LQ057V3DG02

The technical literature is subject to change without notice.
So, please contact SHARP or its representative before designing
your product based on this literature.

ENGINEERING DEPARTMENT
MOBILE LIQUID CRYSTAL DISPLAY DIVISIONIII
MOBILE LIQUID CRYSTAL DISPLAY GROUP
SHARP CORPORATION

NOTICE

This publication is the proprietary of SHARP and is copyrighted, with all rights reserved. Under the copyright laws, no part of this publication may be reproduced or transmitted in any form or by any means, electronic or mechanical for any purpose, in whole or in part, without the express written permission of SHARP. Express written permission is also required before any use of this publication may be made by a third party.

The application circuit examples in this publication are provided to explain the representative applications of SHARP's devices and are not intended to guarantee any circuit design or permit any industrial property right or other rights to be executed. SHARP takes no responsibility for any problems related to any industrial property right or a third party resulting from the use of SHARP's devices, except for those resulting directly from device manufacturing processes.

In the absence of confirmation by device specification sheets, SHARP takes no responsibility for any defects that occur in equipment using any of SHARP's devices, shown in catalogs, data books, etc. Contact SHARP in order to obtain the latest device specification sheets before using any SHARP's device.

SHARP reserves the right to make changes in the specifications, characteristics, data, materials, structures and other contents described herein at any time without notice in order to improve design or reliability. Contact SHARP in order to obtain the latest specification sheets before using any SHARP's device. Manufacturing locations are also subject to change without notice.

Observe the following points when using any device in this publication. SHARP takes no responsibility for damage caused by improper use of the devices.

The devices in this publication are designed for general electronic equipment use.

The appropriate design measures should be taken to ensure reliability and safety when SHARP's devices are used for equipment such as:

- Transportation control and safety equipment (i.e., aircraft, trains, automobiles, etc.)
- Traffic signals • Gas leakage sensor breakers • Alarm equipment • Various safety devices etc.

SHARP's devices shall not be used for equipment that requires extremely high level of reliability, such as:

- Military and space applications • Nuclear power control equipment
- Medical equipment for life support

Contact a SHARP representative, in advance, when intending to use SHARP's devices for any "specific" applications other than those recommended by SHARP.

Contact and consult with a SHARP representative if there are any questions about the contents of this publication.

1 Applicable TFT-LCD module

This specification applies to the color TFT-LCD module, LQ057V3DG02.

2 Overview

This module is a color active matrix transmissive LCD module incorporating amorphous silicon TFT (Thin Film Transistor).

It is composed of a color TFT-LCD panel, driver ICs, control circuits and power supply circuitry and a backlight unit. Graphics and texts can be displayed on a 640 x RGB x 480 dots panel with 262,144 colors by feeding 18 bit data signal (6bit/each of R,G,B), 4(four) timing signals, +3.3V DC power supply for TFT-LCD and AC power supply for backlight.

- Fine images with stripe aligned 307,200 pixels on 5.7 inch diagonal screen
- Color display capability of 262,144 colors with 18 bit data signal(6 bits for each RGB)
- Adapting a wide viewing angle technology [best viewing angle: 12 o'clock direction]
(6 o'clock direction is also available by the function to flip the screen horizontally or vertically)
- High contrast, thanks to active matrix drive system
- AG(Anti Glare) polarizing filter
- Light and slim compact module achieved by COG assemble technology
- Natural coloring reproducibility by employing normally-white-mode, which has good nature in coloring
- Image inversion both horizontally and vertically
- LED drive circuit is built in this module to provide PWM Dimmer function.

3 Mechanical Specifications

items	specifications	unit
Display size (Diagonal)	14.4 (5.7")	cm
Active display area	115.2 (H) x 86.4 (V)	mm
Pixel format	640(H) x RGB x 480(V)	dot
	(1 pixel=R+G+B dots)	-
Pixel pitch	0.18[H] x 0.18[V]	mm
Pixel configuration	R,G,B vertical stripe	-
LCD mode	Normally white	-
Dimension *	144 (W) x 104.6 (H) x 12.3(D)	mm
Mass	TBD (max)	g

* Protrusion such as backlight harness and positioning boss are not included.

Fig.1 shows dimensions of the module.

4 Input Signal Assignment

4.1 TFT-LCD Panel driving section

Employed connector: IMSA-9637S-33Y902 (IRISO ELECTRONICS CO.,LTD.)

Terminal : 0.5mm pitch, bottom contact, Au plating

Pin No.	Symbol	Function	Polarity
1	GND	Ground	
2	CK	Clock signal for sampling each data signal	
3	Hsync	Horizontal synchronous signal	
4	Vsync	Vertical synchronous signal	
5	GND	Ground	
6	R0	RED data signal(LSB)	
7	R1	RED data signal	
8	R2	RED data signal	
9	R3	RED data signal	
10	R4	RED data signal	
11	R5	RED data signal(MSB)	
12	GND	Ground	
13	G0	GREEN data signal(LSB)	
14	G1	GREEN data signal	
15	G2	GREEN data signal	
16	G3	GREEN data signal	
17	G4	GREEN data signal	
18	G5	GREEN data signal(MSB)	
19	GND	Ground	
20	B0	BLUE data signal(LSB)	
21	B1	BLUE data signal	
22	B2	BLUE data signal	
23	B3	BLUE data signal	
24	B4	BLUE data signal	
25	B5	BLUE data signal(MSB)	
26	TEST1	TEST1(Please be sure to connect 26pin with ground)	
27	ENAB	Data enable signal (signal to settle the horizontal display position)	【Note 1】
28	Vcc	+3.3V power supply	
29	Vcc	(Supply same voltage to 28 and 29 pin)	
30	R/L	Selection signal for horizontal scanning direction (“L” : Normally , “H” : Right-and-Left reversal)	【Note 2】
31	U/D	Selection signal for vertical scanning direction (“H” : Normally , “L” : Up-and-Down reversal)	【Note 2】
32	TEST2	TEST2(to be fixed to “High”)	
33	TEST3	TEST3(Please be sure to connect 33pin with ground)	

The back shield case is internally grounded to GND of the module.

The front shield case is not certainly grounded to GND of the module.

【Note 1】

The horizontal display location is designated and controlled by rising timing of ENAB signal.

However if ENAB signal is fixed to “Low”, display location is designated by the default setting in the module.

(Don't use the module by fixing ENAB to “High”)See: Chapter 7-2

【Note 2】

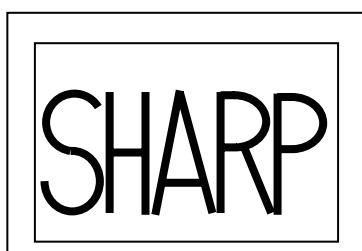

R/L = L, U/D = H



R/L = H, U/D = H

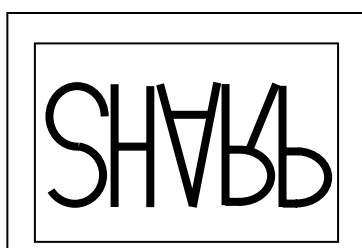

R/L = L, U/D = L

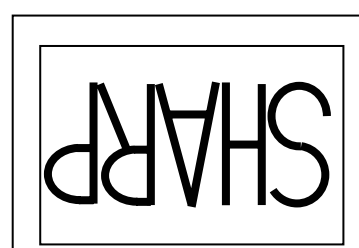

R/L = H, U/D = L

4.2 LED drive circuit section

Employed connector: SM06B-SRSS- TB(LS) (SN) (JST:0.5mm pitch)

Adapted connector: SHR-06V-S-B · SHR-06V-S (JST)

CN2

Pin no.	Symbol	Function
1	V _{LED}	LED drive circuit power supply (12V)
2	V _{LED}	LED drive circuit power supply (12V)
3	GND	Ground
4	GND	Ground
5	PWM	PWM Dimmer
6	LEDO	LED OPEN[normal:High(5V), open error:Low]

5 Absolute Maximum Ratings

Parameter	Symbol	Condition	Ratings	Unit	Remark
Supply voltage	V _{cc}	T _a =25°C	0 ~ +4.6	V	-
LED drive circuit supply voltage	V _{cc}	T _a =25°C	-0.3 ~ + 35	V	-
Input signal voltage	V _I	T _a =25°C	-0.3 ~ + V _{cc} +0.3	V	[Note 1]
PWM Dimmer signal voltage	V _{PWM}	T _a =25°C	- 0.3 ~ +6	V	
Storage temperature	T _{stg}	-	TBD	°C	[Note 2]
Operating temperature (Panel surface)	T _{opp}	-	TBD	°C	

[Note 1] CK, R0 ~ R5, G0 ~ G5, B0 ~ B5, Hsync, Vsync, ENAB, R/L, U/D

[Note 2] Humidity: Less than 95%RH at T_a ≤ 40°C and

Maximum wet-bulb temperature must not exceed 39°C at T_a>40°C,
with no condensation.

6 Electrical characteristics

6.1 TFT-LCD Panel driving section

Ta=25°C

Parameter	Symbol	MIN	TYP	MAX	Unit	Remarks
Supply voltage	Vcc	+3.0	+3.3	+3.6	V	[Note1]
Current dissipation	Icc	-	(220)	-	mA	[Note2] VCC=3.3V
Allowed input ripple voltage	V _{RF}	-	-	100	mV p-p	VCC=3.3V
Input voltage ("Low" state)	V _{IL}	0	-	0.3V _{cc}	V	[Note3]
Input voltage ("High" state)	V _{IH}	0.7V _{cc}	-	V _{cc}	V	
Input leakage current (low)	I _{OL1}	-	-	4.0	μA	V _i =0V [Note4]
	I _{OL2}	-	-	4.0	μA	V _i =0V [Note5]
Input leakage current (High)	I _{OH1}	-	-	4.0	μA	V _i =3.3V [Note4]
	I _{OH2}	-	-	360.0	μA	V _i =3.3V [Note5]

[Note1] Vcc turn-on/off conditions

$$1s < t_0$$

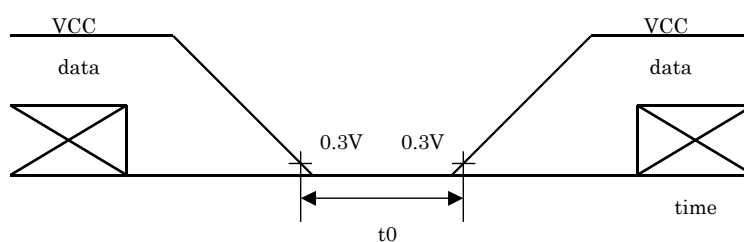
Vcc-dip conditions1) At $2.7V \leq V_{cc} < 3.0V$

$$t_d \leq 10ms$$

2) At $V_{cc} < 2.7V$

Vcc dip conditions should also follow
the Vcc turn-on/off conditions

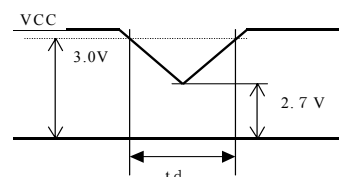

[Note2] Current dissipation (Typ.): When Black pattern is displayed.

[Note3] CK, R0~R5, G0~G5, B0~B5, Hsync, Vsync, ENAB, R/L, U/D

[Note4] R0~R5, G0~G5, B0~B5, Hsync, Vsync and ENAB

[Note5] R/L, U/D

6-2 Vcc turn-on/off conditions

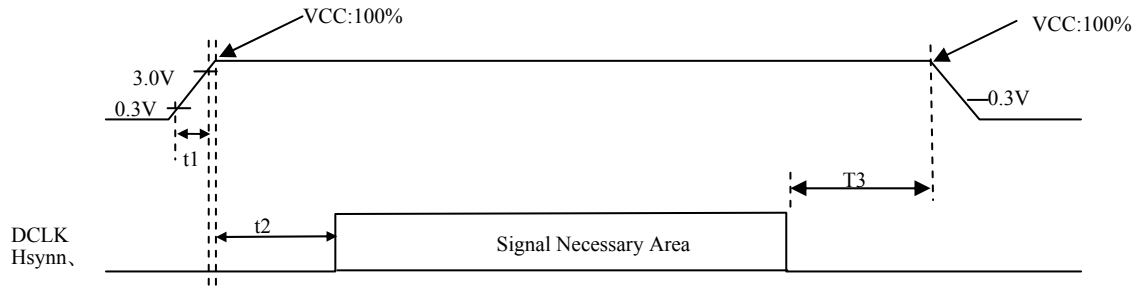

- ⊙ Every Signal is CMOS Input, Hi-Z is prohibited when VCC is on level.
Please avoid the input of the signal voltage more than Supply voltage (VCC).

	Min.	Typ.	Max.	unit
t1	0	-	10	ms
t2	0	-	50	ms
t3	0	-	100	ms

6-3 LED drive circuit section

Parameter	Symbol	MIN	TYP	MAX	Unit	Remarks
Input voltage	V_{LED}	11.2	12.0	12.6	V	
Current dissipation	I_{LED}	-	(300)	-	mA	$V_{LED} = 12.0V$
Dimmer signal Low voltage	$V_{PWM L}$	-	-	0.2	V	
Dimmer signal High voltage	$V_{PWM H}$	1.4	5.0	(12)	V	
Dimmer frequency	f_{PWM}	-	120	-	Hz	
PWM Pulse width	$T_{PWM H}$	(10)	-	-	μs	High period
LED OPEN voltage (normal)	$V_{LEDO H}$	(4.5)	5.0	(5.5)	V	@ $I_{LEDO H} = 1\mu A$
LED OPEN voltage (error)	$V_{LEDO L}$	0	-	(0.3)	V	@ $I_{LEDO L} = 50\mu A$

PWM Dimmer function

- PWM Dimmer function can be available by input PWM pulse into a PWM terminal and changing the duty ratio of Hi/Lo.
(PWM = High : ON , PWM = Low : OFF)
- Please do not make the PWM terminal in a floating state (no input state).
Please be connected to the GND at the waiting time.
- Please input PWM signal after $V_{LED}(12V)$ is supplied.
- Please turn off $V_{LED}(12V)$ after PWM signal is stopped.

7 Timing Characteristics of Input Signals

Timing diagrams of input signal are shown in Fig.2.

7.1 Timing Characteristics

Parameter		Symbol	MIN.	TYP.	MAX.	Unit	Note
Clock	Frequency	1/Tc	24.3	25.2	26.54	MHz	
	“High” time	Tch	10	—	—	ns	
	“Low” time	Tcl	10	—	—	ns	
Data	Setup time	Tds	5	—	—	ns	
	Hold time	Tdh	5	—	—	ns	
Hsync	Period	TH		31.75		μs	
			780	800	820	clock	±20clock
	Pulse width	THp	2	—	TH-10	clock	
Vsync	Period	TV	520	525	530	line	60Hz
	Pulse width	TVp	2	—	519	line	
Horizontal display period		THd	—	640	—	clock	
Phase difference between Hsync and clock		THc	5	—	Tc-10	ns	
Phase difference between Hsync and Vsync		TVh	0	—	50	clock	
Vertical back porch		TVs		34(fixed)			
Vertical front porch		TVf	6		16		※
Vertical display period		TVd	—	480	—	line	

Note) In case of lower frequency, the deterioration of display quality, flicker etc., may occur.

$$※TVf = TV - TVs(34) - TVd(480)$$

7.2 Display Position in horizontal direction

Display position in horizontal direction is designated by rising timing of ENAB signal.

Parameter		Symbol	MIN	TYP	MAX	Unit	Note
ENAB signal	Setup time	Tes	5	—	Tc-10	ns	
	Pulse width	Tep	—	640	—	clock	
Phase difference between Hsync and ENAB signal		THE	44	—	104	clock	

When ENAB is fixed to “Low”, the horizontal display will starts from the clock C104 (clock) as shown in Fig.2.

7.3 Display position in vertical direction

Display start position in vertical direction TVs is fixed to the 34th line.

8 Input Signals, Basic Display Colors and Gray Scale of Each Color.

Display position of input data

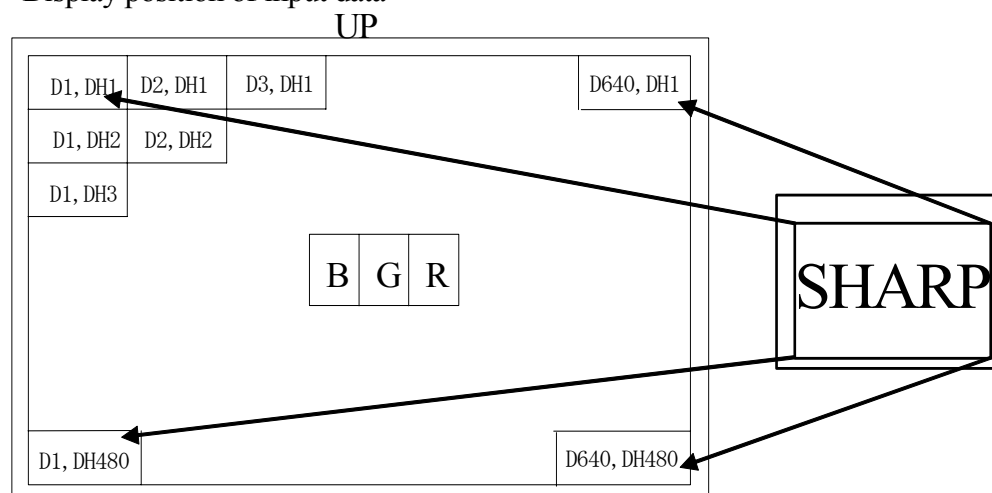

	Colors & Gray scale	Data signal																		
		Gray Scale	R0	R1	R2	R3	R4	R5	G0	G1	G2	G3	G4	G5	B0	B1	B2	B3	B4	B5
Basic Color	Black	-	0	0	0	0	0	0	0	0	0	0	0	0	0	0	0	0	0	0
	Blue	-	0	0	0	0	0	0	0	0	0	0	0	0	1	1	1	1	1	1
	Green	-	0	0	0	0	0	0	1	1	1	1	1	1	0	0	0	0	0	0
	Cyan	-	0	0	0	0	0	0	1	1	1	1	1	1	1	1	1	1	1	1
	Red	-	1	1	1	1	1	1	0	0	0	0	0	0	0	0	0	0	0	0
	Magenta	-	1	1	1	1	1	1	0	0	0	0	0	0	1	1	1	1	1	1
	Yellow	-	1	1	1	1	1	1	1	1	1	1	1	1	0	0	0	0	0	0
	White	-	1	1	1	1	1	1	1	1	1	1	1	1	1	1	1	1	1	1
Gray Scale of Red	Black	GS0	0	0	0	0	0	0	0	0	0	0	0	0	0	0	0	0	0	0
	↑	GS1	1	0	0	0	0	0	0	0	0	0	0	0	0	0	0	0	0	0
	Darker	GS2	0	1	0	0	0	0	0	0	0	0	0	0	0	0	0	0	0	0
	↑	↓				↓				↓							↓			
	↓	↓				↓				↓							↓			
	Brighter	GS61	1	0	1	1	1	1	0	0	0	0	0	0	0	0	0	0	0	0
	↓	GS62	0	1	1	1	1	1	0	0	0	0	0	0	0	0	0	0	0	0
	Red	GS63	1	1	1	1	1	1	0	0	0	0	0	0	0	0	0	0	0	0
Gray Scale of Green	Black	GS0	0	0	0	0	0	0	0	0	0	0	0	0	0	0	0	0	0	0
	↑	GS1	0	0	0	0	0	0	1	0	0	0	0	0	0	0	0	0	0	0
	Darker	GS2	0	0	0	0	0	0	0	1	0	0	0	0	0	0	0	0	0	0
	↑	↓				↓				↓							↓			
	↓	↓				↓				↓							↓			
	Brighter	GS61	0	0	0	0	0	0	1	0	1	1	1	1	0	0	0	0	0	0
	↓	GS62	0	0	0	0	0	0	0	1	1	1	1	1	0	0	0	0	0	0
	Green	GS63	0	0	0	0	0	0	1	1	1	1	1	1	0	0	0	0	0	0
Gray Scale of Blue	Black	GS0	0	0	0	0	0	0	0	0	0	0	0	0	0	0	0	0	0	0
	↑	GS1	0	0	0	0	0	0	0	0	0	0	0	0	1	0	0	0	0	0
	Darker	GS2	0	0	0	0	0	0	0	0	0	0	0	0	0	1	0	0	0	0
	↑	↓				↓				↓							↓			
	↓	↓				↓				↓							↓			
	Brighter	GS61	0	0	0	0	0	0	0	0	0	0	0	0	1	0	1	1	1	1
	↓	GS62	0	0	0	0	0	0	0	0	0	0	0	0	0	1	1	1	1	1
	Blue	GS63	0	0	0	0	0	0	0	0	0	0	0	0	1	1	1	1	1	1

0: Low level voltage, 1: High level voltage

Each basic color can be displayed in 64 gray scales from 6 bit data signals. According to the combination of total 18 bit data signals, the 262,144-color display can be achieved on the screen.

9 Optical Specification

Ta=25°C, Vcc=+3.3V, VLED=+12V

Parameter	Symbol	Condition	Min.	Typ.	Max.	Unit	Remark	
Viewing angle Range	Horizontal	CR≥5	-	(80)	-	° (Deg.)	[Note9-1,4]	
	Vertical		θ11	-	(80)	-		° (Deg.)
			θ12	-	(70)	-		° (Deg.)
Contrast ratio	CR max	Best viewing angle	(200)	(600)	-	-	[Note9-2]	
Response time	Rise	θ = 0°	-	(8)	(20)	ms	[Note9-3]	
	Fall		Td	-	(21)	(40)		ms
Chromaticity of white	x	θ = 0°	-	(0.313)	-	-	[Note9-4]	
	y		-	(0.329)	-	-		
Luminance	Y		-	(400)	-	cd/m ²		

The optical specifications are measured 30 minute after turning on and in a dark room or equivalent condition, according to the method shown in Fig.9-1, 2 below.

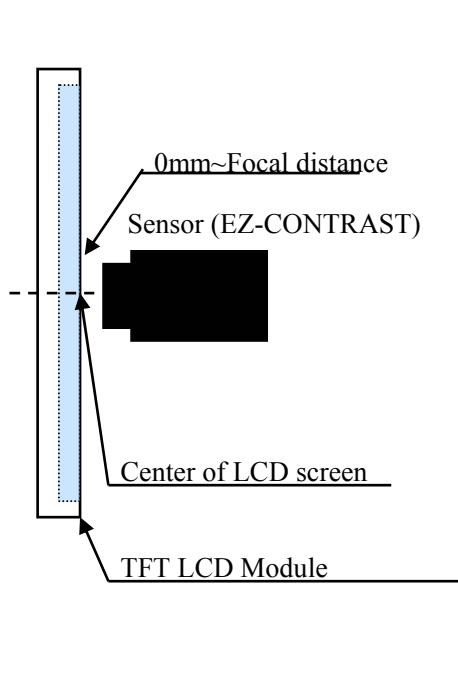

Fig.9-1 Measuring setup for
Viewing angle and Contrast ratio
(BM-5A is used for contrast.)

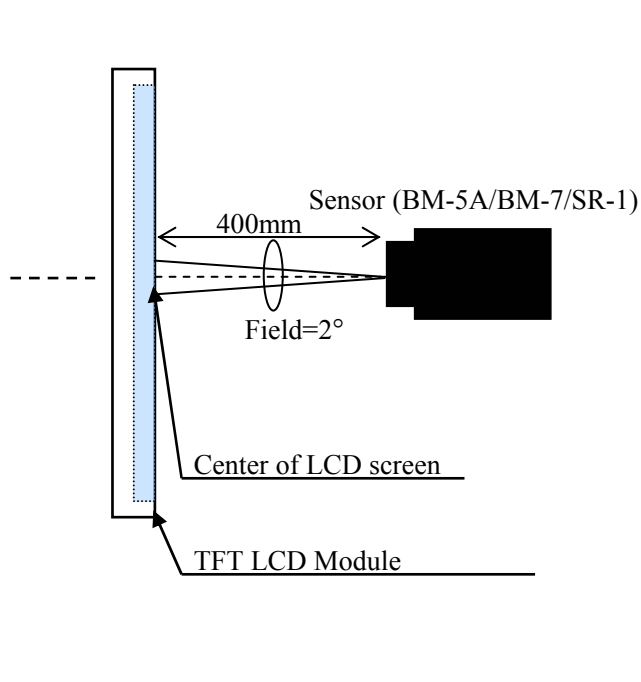
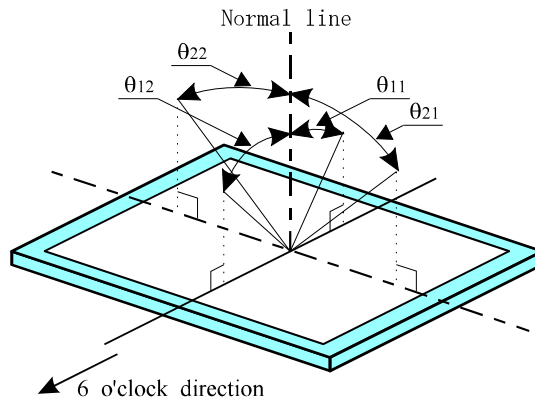

Fig.9-2 Measuring setup for
Luminance, Chromaticity
and Response time
(BM-7 is used for Luminance, SR-1 is for response)

[Note9-1] Definitions of viewing angle range:



The best viewing angle of this module is slightly leaned to 12 o'clock from normal line.

Where $\theta_{11} > \theta_{\max}$, gray scale is reversed partially.

Where $\theta_{11} < \theta_{\max}$, or in θ_{12} direction, gray scale isn't reversed.

[Note9-2] Definition of contrast ratio:

The contrast ratio is defined as the following.

$$\text{Contrast Ratio (CR)} = \frac{\text{Central luminance(brightness) with all pixels white}}{\text{Central luminance(brightness) with all pixels black}}$$

[Note9-3] Definition of response time:

The response time is defined as the following figure and shall be measured by switching the input signal between "black" and "white" alternatively.

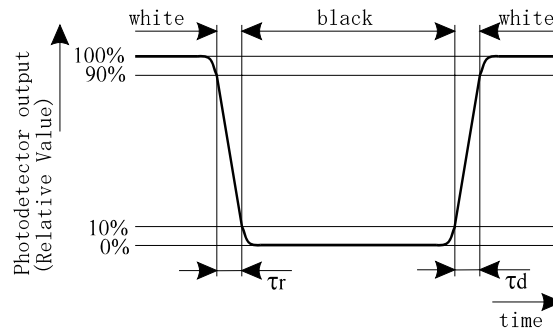

[Note9-4] This parameter should be measured at the center of the screen and 30 minutes after turn-on.
The characteristics are measured when the driver circuit is not powered.

10 Display Qualities

Please refer to the Outgoing Inspection Standard.

11 Handling Instruction

11.1 Assembling the module

- 1) The TFT-LCD module is designed to be mounted on equipment using the mounting tabs in the four corners of the module at the rear side. On mounting the module, as the nominal diameter 3.0mm tapping screw (fastening torque is 0.25 through 0.30 N·m) is recommended, be sure to fix the module on the same plane, taking care not to wrap or twist the module. The depth of tapping screw embedded into LCD module must be less than 5mm.

The pressing module, (ex. touching switch etc.) causes disordered image. So taking care for pressure not to conduct directly to LCD module.

- 2) Please power off the module before you connect or disconnect input connector..

11.2 Precautions in mounting

- 1) Polarizer which is made of soft material and susceptible to flaw must be handled carefully.
- 2) Method of removing dust from polarizer.
 - Blow off dust with N2 blower for which static electricity preventive measure has been taken.
 - Since the polarizer is easily damaged, wiping should be avoided. If the panel has stain or finger grease, we recommend to use adhesive tape to softly remove them from the panel. Inevitable, wipe off by cleaning cloth for a lens with carefully, breathing on it.
- 3) When metal part of the TFT-LCD module (shielding lid and rear case) is soiled, wipe it with soft dry cloth. For stubborn dirties, wipe the part, breathing on it.
- 4) Wipe off water drop or finger grease immediately. Long contact with water may cause discoloration or spots.
- 5) TFT-LCD module uses glass which breaks or cracks easily if dropped or bumped on hard surface handle with care.
- 6) Since CMOS LSIs are incorporated in this module, take care of electrostatic and earth human body while handling.

11.3 Caution in product design

The notes and cautions below should be followed when product is designed with this module.

The module should be protected with cover to prevent salt content and/or water droplet.

Take enough shielding countermeasure not to interfere to peripheral electronic device.

11.4 Others

- The LCD has the nature that its performance is degradation by ultra-violet light. Don't leave the LCD module in direct sunlight or strong ultra violet ray.

- If stored at the temperatures lower than the rated storage temperature, the LC may freeze and it may cause LCD panel damage. If storage temperature exceeds the specified rating, the molecular orientation of the LC may change to that of a liquid, and they may not revert to their original state. Store the module in normal room temperature.

- The inductive loss caused by routing of lamp lead wire, which is closed to conductive section, may require the kick-off voltage greater than specified kick-off voltage.

- The liquid crystal may leak out when the LCD is broken. If the liquid crystal drip into the eyes or mouth washes it out immediately.

- Avoid the Device to use and leave in the atmosphere described below:

Condensation and/or the high concentration of corrosive gases.

- The caution to other ordinal electronic component should be followed also.

12 Reliability Test Items

No.	Test parameter	Conditions
1	High temperature storage test	Leaves the module at Ta= TBD °C for 240h
2	Low temperature storage test	Leaves the module at Ta= TBD °C for 240h
3	High temperature & high humidity operation test	Operates the module at Ta=40°C; 90~95%RH for 240h (No condensation)
4	High temperature operation test	Operates the module with TBD °C at panel surface for 240h
5	Low temperature operation test	Operates the module at Ta= TBD °C for 240h
6	Strength against ESD	±200V·200pF [0Ω] one time for each terminal
7	Shock test (non- operating)	Max. acceleration : 980m/s ² Pulse width : 6ms, half sine wave Direction : ±X,±Y,±Z once for each direction.
8	Vibration test (non- operating)	Frequency : 10~57Hz/Vibration width (one side):0.15mm : 57~500Hz/ acceleration:19.6m/s ² Sweep time : 6 minutes Test period : 3 hours (1 hour for each direction of X,Y,Z)
9	Thermal shock test	TBD °C ~ TBD °C /50 cycle [0.5h] [0.5h]

[Result Evaluation Criteria]

Under the display quality test conditions with normal operation state, these shall be no change which may affect practical display function.

[Note] The directions of X, Y, Z are defined as below:

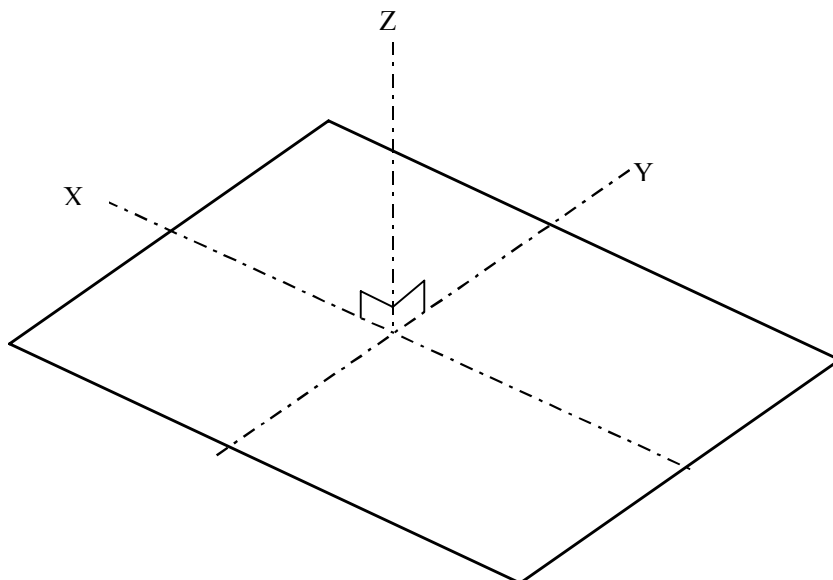

13 Packing Form

13.1 Fig.3 shows packaging form. **TBD**

13.2 Carton stock conditions

- a) Maximum number of Carton being stuck: Max. **TBD** cartons
- b) Maximum number of product contained: **TBD** Unit
- c) Carton size: **TBD** mm(W)×**TBD** mm(H)×**TBD** mm(D)
- d) Total mass : **TBD** kg
- e) Carton stock environment:
 - 1) Temperature: 0 ~ 40°C
 - 2) Humidity: Up to 60%RH
 - 3) Ambiance: No gases bite into electronic components and wiring materials
 - 4) Period: Approximately 3month
 - 5) Unpacking: To prevent LCD module from damaging by ESD, unpack the module with effective measure after controlling humidity 50%RH or more.

14 Marking of product name

1. Serial No. indication

Serial No. is indicated by labeling. The location is given in Fig.1 Outline dimension.

Indicated contents:

LQ057V3DG02	7X000001X
Model name	Serial No.

Serial No. contents	1st digit:	last digit of produced year (ex. 2007 → “7”)
	2nd digit:	Produced month 1, 2, 3 ~ 9, X, Y, Z
	3rd ~ 8th digit:	Sequential number 000001 ~
	9th digit:	Interoffice control code

(There is it in the case of the blank.)

2. Don't disassemble this module, it may cause malfunction.
3. Image retention may occur when the fixed image is display for long time.
4. Liquid crystal panel drive input FFC/FPC specification
 - Refer to the one that the size of FFC/FPC was recommended it of input connector.
[IMSA-9637S-33Y902(IRISO ELECTRONICS CO.,LTD.), 33pin 0.5mm pitch]
 - The terminal of FFC/FPC of input connector recommend gold or gold plating specification.
Because point of contact with its is gold plating specification.

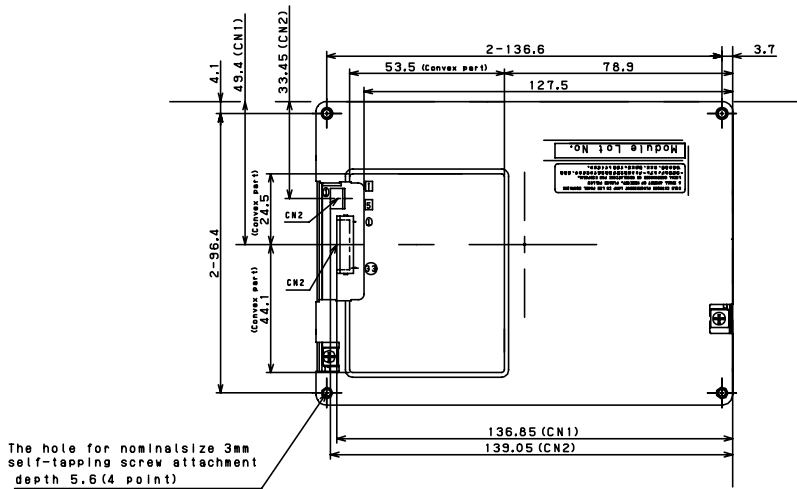
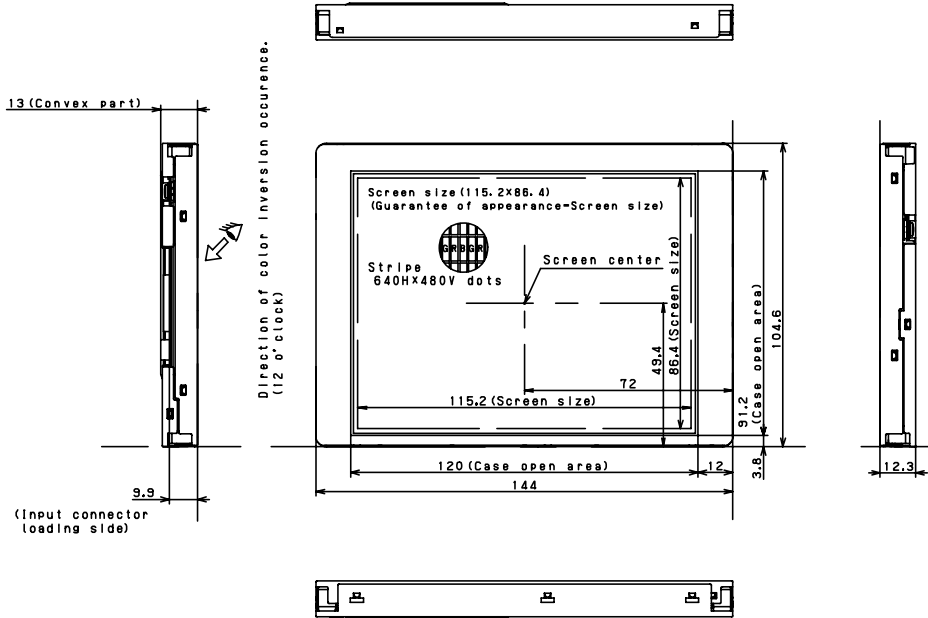

※Input terminal arrangement

① CN1

GND
CK
HSYNC
VSYNC
GND
R0
R1
R2
R3
R4
R5
GND
G0
G1
G2
G3
G4
G5
GND
B0
B1
B2
B3
B4
R/G11
R/G12
R/G13
R/G14
R/G15
R/G16
R/G17
R/G18
R/G19
R/G20
R/G21
R/G22
R/G23
R/G24
R/G25
R/G26
R/G27
R/G28
R/G29
R/G30
R/G31
R/G32
R/G33
R/G34
R/G35
R/G36
R/G37
R/G38
R/G39
R/G40
R/G41
R/G42
R/G43
R/G44
R/G45
R/G46
R/G47
R/G48
R/G49
R/G50
R/G51
R/G52
R/G53
R/G54
R/G55
R/G56
R/G57
R/G58
R/G59
R/G60
R/G61
R/G62
R/G63
R/G64
R/G65
R/G66
R/G67
R/G68
R/G69
R/G70
R/G71
R/G72
R/G73
R/G74
R/G75
R/G76
R/G77
R/G78
R/G79
R/G80
R/G81
R/G82
R/G83
R/G84
R/G85
R/G86
R/G87
R/G88
R/G89
R/G90
R/G91
R/G92
R/G93
R/G94
R/G95
R/G96
R/G97
R/G98
R/G99
R/G100

② CN2

L2V
L2V
GND
GND
PWM

- 1) Take care in set design to hide the scratches and bubbles appered on the polarizer or other flame area whitch is located outside of active area.
- 2) CN1: I/O connector is IMSA-9637S-33Y902 (IRISO ELECTRICS CO., LTD)
CN2: connector is SM05B-SRSS-TB (LF) (SN) (J. S. T. Mfg. Co., Ltd)
- 3) The whole curvature is not included thickness direction.
- 4) Recommendation screw is normal size 3mm tapping amount of invation 5mm.
- 5) General tolerance is $\pm 0.5\text{mm}$.