



MODEL NO. TM150TCS01

ISSUED DATE: 2011/05/20

VERSION : 1.0

Preliminary Specification
 Final Product Specification

Customer : _____

Approved by	Notes

SHANGHAI AVIC Confirmed :

Prepared by	Checked by	Approved by
Wei Zhang		

This technical specification is subjected to change without notice



RECORD OF REVISION

Rev	Issued Date	Description	Editor
1.0	2011-05-20	Preliminary Release	Wei Zhang

AVIC CONFIDENTIAL



CONTENTS

RECORD OF REVISION.....	2
1. OUTLINE.....	5
1.1 STRUCTURE AND PRINCIPLE.....	5
1.2 APPLICATION.....	5
1.3 FEATURES.....	5
2. GENERAL SPECIFICATIONS.....	6
3. BLOCK DIAGRAM.....	7
4. DETAILED SPECIFICATIONS.....	9
4.1 MECHANICAL SPECIFICATIONS.....	9
4.2 ABSOLUTE MAXIMUM RATINGS.....	9
4.3 ELECTRICAL CHARACTERISTICS.....	10
4.3.1 LCD panel signal processing board.....	10
4.3.2 Backlight lamp.....	11
4.3.3 Power supply voltage ripple.....	12
4.3.4 Fuse.....	12
4.4 POWER SUPPLY VOLTAGE SEQUENCE.....	13
4.5 CONNECTIONS AND FUNCTIONS FOR INTERFACE PINS.....	14
4.5.1 LCD panel signal processing board.....	14
4.5.2 Backlight lamp.....	15
4.5.3 Positions of plug and socket.....	15
4.5.4 Connection between receiver and transmitter for LVDS.....	16
4.6 DISPLAY COLORS AND INPUT DATA SIGNALS.....	20
4.7 DISPLAY POSITIONS.....	21
4.8 SCANNING DIRECTIONS.....	21
4.9 INPUT SIGNAL TIMINGS.....	23
4.9.1 Outline of input signal timings.....	23
4.9.2 Timing characteristics.....	24
4.9.3 Input signal timing chart.....	25
4.10 OPTICS.....	26
4.10.1 Optical characteristics.....	26
4.10.2 Definition of contrast ratio.....	27
4.10.3 Definition of luminance uniformity.....	27
4.10.4 Definition of response times.....	27
4.10.5 Definition of viewing angles.....	27
4.11 DEFECT CRITERIA.....	28
4.11.1 Display specifications.....	28
4.11.2 Close defect dots.....	29
4.11.3 Linked defect dots.....	29
4.11.4 Appearance specifications.....	31
5. ESTIMATED LUMINANCE LIFETIME.....	32
6. MARKINGS.....	32
6.1 NAMEPLATE LABEL.....	32
6.2 BARCODE LABEL.....	33
6.3 OTHER MARKINGS.....	33
7. PACKING, TRANSPORTATION AND DELIVERY.....	34
7.1 INNER PACKING BOX.....	34
7.2 OUTER PACKING BOX.....	34
7.3 INSPECTION RECORD SHEET.....	34
7.4 TRANSPORTATION.....	34
7.5 SIZE AND WEIGHT FOR PACKING BOXES.....	34

The information contained herein is the exclusive property of SHANGHAI AVIC OPTOELECTRONICS Corporation, and shall not be distributed, reproduced, or disclosed in whole or in part without prior written permission of SHANGHAI AVIC OPTOELECTRONICS Corporation.



7.6 OUTLINE FIGURE FOR PACKING..... 35

8. PRECAUTIONS..... 37

8.1 MEANING OF CAUTION SIGNS..... 37

8.2 CAUTIONS..... 37

8.3 ATTENTIONS..... 37

 8.3.1 Handling of the product..... 37

 8.3.2 Environment..... 38

 8.3.3 Characteristics..... 38

 8.3.4 Other..... 39

9. OUTLINE DRAWINGS..... 40

9.1 FRONT VIEW..... 40

9.2 REAR VIEW..... 41

AVIC CONFIDENTIAL



1. OUTLINE

1.1 STRUCTURE AND PRINCIPLE

Color LCD module TMS150SCS01 is composed of the amorphous silicon thin film transistor liquid crystal display (a-Si TFT LCD) panel structure with driver LSIs for driving the TFT (Thin Film Transistor) array and a backlight.

The a-Si TFT LCD panel structure is injected liquid crystal material into a narrow gap between the TFT array glass substrate and a color-filter glass substrate.

Color (Red, Green, Blue) data signals from a host system (e.g. signal generator, etc.) are modulated into best form for active matrix system by a signal processing board, and sent to the driver LSIs which drive the individual TFT arrays.

The TFT array as an electro-optical switch regulates the amount of transmitted light from the backlight assembly, when it is controlled by data signals. Color images are created by regulating the amount of transmitted light through the TFT array of red, green and blue dots.

1.2 APPLICATION

- ◆ For industrial use

1.3 FEATURES

- ◆ Wide viewing angle
- ◆ Fast response time
- ◆ LVDS interface (8-bit)
- ◆ Selectable LVDS input map
- ◆ Reversible-scan direction
- ◆ Small foot print
- ◆ Edge light type backlight (without inverter)
- ◆ Replaceable lamp for backlight
- ◆ Acquisition product for UL60950-1/CSA C22.2 No.60950-1-03 (File number: E170632)
- ◆ Compliant with the European RoHS directive (2002/95/EC)

**2. GENERAL SPECIFICATIONS**

Display area	304.128 (H) ► 228.096 (V) mm
Diagonal size of display	38cm (15.0 inches)
Drive system	a-Si TFT active matrix
Display color	16,777,216 colors (6bit+FRC)
Pixel	1,024 (H) ► 768 (V) pixels
Pixel arrangement	RGB (Red dot, Green dot, Blue dot) vertical stripe
Dot pitch	0.099 (H) ► 0.297 (V) mm
Pixel pitch	0.297 (H) ► 0.297 (V) mm
Module size	326.5 (typ., W) ► 253.5 (typ., H) ► 12.0 (max., D) mm Note1
Weight	970g (typ.)
Contrast ratio	500:1 (typ.)
Viewing angle	<i>At the contrast ratio ◀ 10:1</i> <ul style="list-style-type: none"> ◆ Horizontal: Right side 80► (typ.), Left side 80► (typ.) ◆ Vertical: Up side 80► (typ.), Down side 80► (typ.)
Designed viewing direction	<i>At DPS terminal= Low or Open: Normal scan</i> <ul style="list-style-type: none"> ◆ Viewing direction without image reversal: up side (12 o'clock) ◆ Viewing direction with contrast peak: down side (6 o'clock) ◆ Viewing angle with optimum grayscale (→ ≐2.2): normal axis (perpendicular)
Polarizer surface	Antiglare
Polarizer pencil-hardness	3H (min.) [by JIS K5400]
Color gamut	<i>At LCD panel center</i> 50% (typ.) [against NTSC color space]
Response time	<i>Ton+Toff (10%↔ 90%)</i> 18ms (typ.)
Luminance	<i>At IBL=7.5mAmps / lamp</i> 250cd/m ² (typ.)
Signal system	LVDS 1port (Receiver: Equivalent of THC63LVDF84B, Thine Electronics Inc.) [8-bit digital signals for data of RGB colors, Dot clock (CLK), Data enable (DE)]
Power supply voltage	LCD panel signal processing board: 3.3V
Backlight	Edge light type: 2 cold cathode fluorescent lamps (without inverter)
Power consumption	<i>At IBL = 7.5mAmps / lamp, Checkered flag pattern</i> 10.0W (typ., Power dissipation of the inverter is not included.)

Note1: Excluding lamp cables and projection.



3. BLOCK DIAGRAM

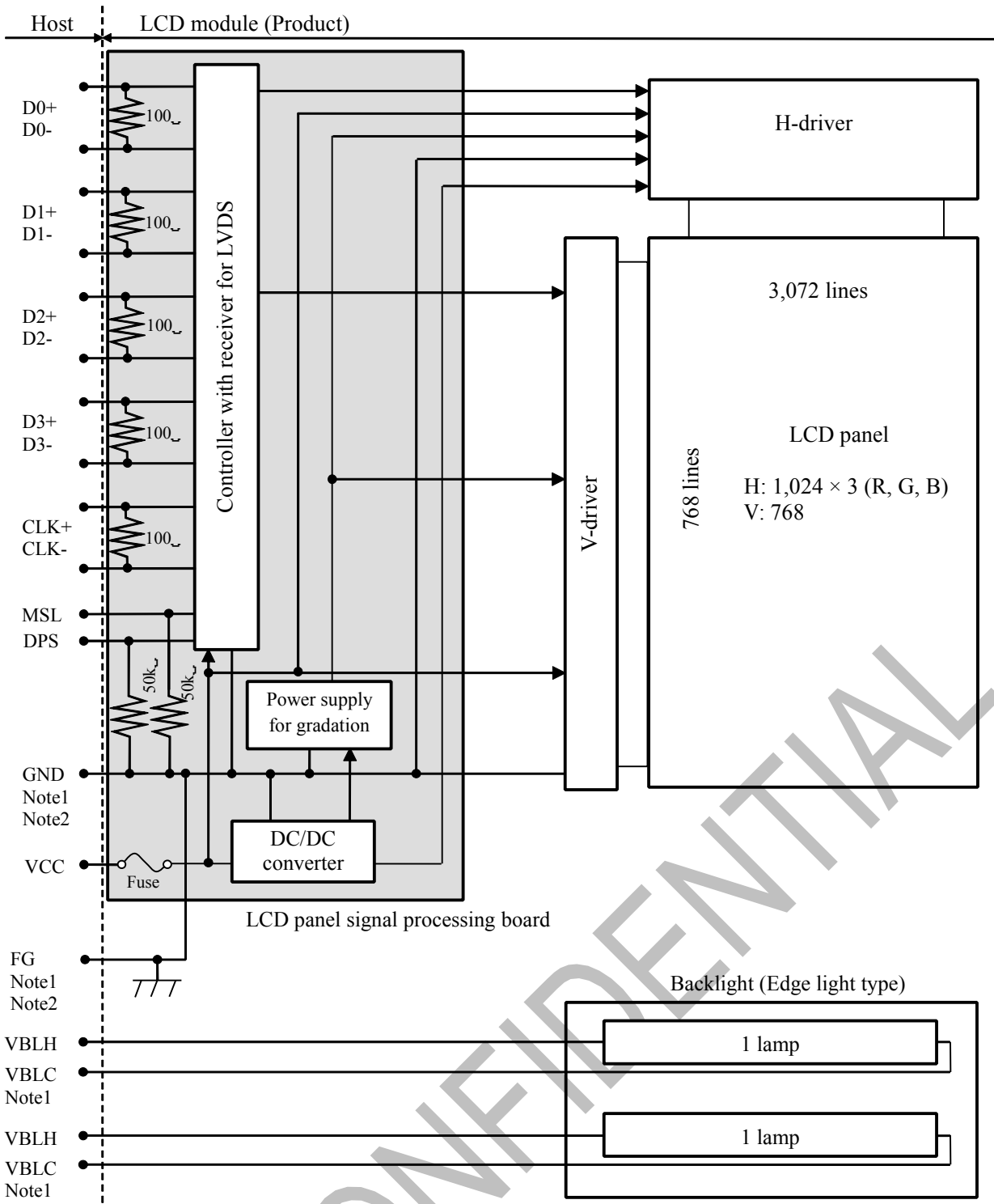



Note1: Relations between GND (Signal ground), FG (Frame ground) and VBLC (Lamp low voltage terminal) in the product are as follows.

GND-FG	Connected
GND-VBLC	Not connected
FG-VBLC	Not connected

Note2: GND and FG must be connected to customer equipment's ground, and it is recommended that GND, FG and customer inverter ground are connected together in customer equipment.

AVIC CONFIDENTIAL



4. DETAILED SPECIFICATIONS

4.1 MECHANICAL SPECIFICATIONS

Parameter	Specification	Unit
Module size	326.5 \pm 0.5 (W) \times 253.5 \pm 0.5 (H) \times 12.0 max. (D)	mm
Display area	304.128 (H) \times 228.096 (V)	mm
Weight	970 (typ.), 1,050 (max.)	g

Note1: Excluding lamp cables and projection.

Note2: See "11. OUTLINE DRAWINGS".

4.2 ABSOLUTE MAXIMUM RATINGS

Parameter		Symbol	Rating	Unit	Remarks
Power supply voltage	LCD panel signal processing board	VCC	-0.3 to +3.6	V	-
	Lamp voltage	VBLH	2,000	Vrms	
Input voltage for signals	Display signals Note1	VD	-0.3 to +3.6 and \pm VCC +0.3	V	
	Function signals Note2	VF			
Storage temperature		Tst	-20 to +80	\rightarrow C	-
Operating temperature	Front surface	TopF	-20 to +70	\rightarrow C	Note3
	Rear surface	TopR	-20 to +70	\rightarrow C	Note4
Relative humidity Note5	RH	\uparrow 95	%	Ta \uparrow 40 \rightarrow C	
		\uparrow 85	%	40 < Ta \uparrow 50 \rightarrow C	
		\uparrow 55	%	50 < Ta \uparrow 60 \rightarrow C	
		\uparrow 36	%	60 < Ta \uparrow 70 \rightarrow C	
Absolute humidity Note5	AH	\uparrow 70 Note6	g/m ³	Ta > 70 \rightarrow C	
Operating altitude	-	\uparrow 4,850	m	-20 \rightarrow C \uparrow Ta \uparrow 70 \rightarrow C	
Storage altitude	-	\uparrow 13,600	m	-20 \rightarrow C \uparrow Ta \uparrow 80 \rightarrow C	

Note1: D0+/-, D1+/-, D2+/-, D3+/-, CLK+/-

Note2: MSL, DPS

Note3: Measured at center of LCD panel surface (including self-heat)

Note4: Measured at center of LCD module's rear shield surface (including self-heat)

Note5: No condensation

Note6: Water amount at Ta= 70°C and RH= 36%



4.3 ELECTRICAL CHARACTERISTICS

4.3.1 LCD panel signal processing board

(Ta= 25→C)

Parameter		Symbol	min.	typ.	max.	Unit	Remarks
Power supply voltage		VCC	3.0	3.3	3.6	V	-
Power supply current		ICC	-	500 Note1	700 Note2	mA	at VCC= 3.3V
Permissible ripple voltage		VRP	-	-	100	mVp-p	for VCC
Differential input threshold voltage for LVDS receiver	High	VTH	-	-	+100	mV	at VCM= 1.2V Note3
	Low	VTL	-100	-	-	mV	
Input voltage swing for LVDS receiver		Vi	0	-	2.4	V	-
Terminating resistance		RT	-	100	-	Ω	-
Input voltage for MSL and DPS signals	High	VFH	2.0	-	VCC	V	-
	Low	VFL	0	-	0.8	V	
Input current for MSL and DPS signals	High	IFH	-	-	300	μA	-
	Low	IFL	-300	-	-	μA	

Note1: Checkered flag pattern [by EIAJ ED-2522]

Note2: Pattern for maximum current

Note3: Common mode voltage for LVDS receiver



4.3.2 Backlight lamp

(Ta= 25→C, Note1)

Parameter	Symbol	min.	typ.	max.	Unit	Remarks
Lamp current Note3	IBL	3.5	7.5	8.0	mArms	at IBL=7.5mArms: L= 250cd/m ² (typ.)
Lamp voltage Note2, Note3	VBLH	-	560	-	Vrms	-
Lamp starting voltage Note2, Note3, Note4, Note7	VS	1,300	-	-	Vrms	Ta= 25→C
		1,500	-	-	Vrms	Ta= 0→C
		1,600	-	-	Vrms	Ta= -20→C
Lamp oscillation frequency Note5	FO	45	54	65	kHz	-

Note1: This product consists of 2 backlight lamps, and these specifications are for each lamp.

Note2: The lamp voltage cycle between lamps should be kept on a same phase. "VS" and "VBLH" are the voltage value between low voltage side (Cold) and high voltage side (Hot).

Note3: The asymmetric ratio of working waveform for lamps (Lamp voltage peak ratio, Lamp current peak ratio and waveform space ratio) should be less than 5 % (See the following figure.). If the waveform is asymmetric, DC (Direct current) element apply into the lamp. In this case, a lamp lifetime may be shortened, because a distribution of a lamp enclosure substance inclines toward one side between low voltage terminal (Cold terminal) and high voltage terminal (Hot terminal). When designing the inverter, evaluate asymmetric of lamp working waveform sufficiently.

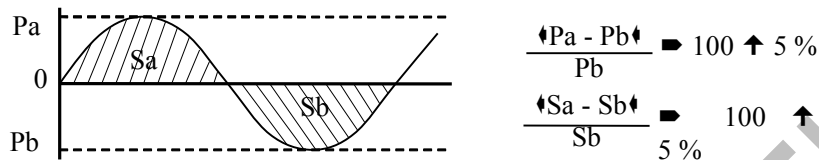

Pa: Supply voltage/current peak for positive, Pb: Supply voltage/current peak for negative
Sa: Waveform space for positive part, Sb: Waveform space for negative part

Note4: The inverter should be designed so that the lamp starting voltage can be maintained for more than 1 second. Otherwise the lamp may not be turned on.

Note5: In case "FO" is not the recommended value, beat noise may display on the screen, because of interference between "FO" and "1/th". Recommended value of "FO" is as following.

$$FO = \frac{1}{4} \rightarrow \frac{1}{th} \rightarrow (2n-1)$$

th: Horizontal signal period (See "4.9.2 Timing characteristics".)

n: Natural number (1, 2, 3, 4, 5, 6, 7, 8, 9, 10, 11, 12, 13, 14, 15, 16, 17, 18, 19, 20, 21, 22, 23, 24, 25, 26, 27, 28, 29, 30, 31, 32, 33, 34, 35, 36, 37, 38, 39, 40, 41, 42, 43, 44, 45, 46, 47, 48, 49, 50, 51, 52, 53, 54, 55, 56, 57, 58, 59, 60, 61, 62, 63, 64, 65, 66, 67, 68, 69, 70, 71, 72, 73, 74, 75, 76, 77, 78, 79, 80, 81, 82, 83, 84, 85, 86, 87, 88, 89, 90, 91, 92, 93, 94, 95, 96, 97, 98, 99, 100)

Note6: Method of lamp cable installation may invite fluctuation of lamp current and voltage or asymmetric of lamp working waveform. When designing method of lamp cable installation, evaluate the fluctuation of lamp current, voltage and working waveform sufficiently.



Note7: In case of Inverter with Ballast condenser, "VS" is the voltage level between Ballast condenser and Connector (Refer to the below "Example of measurement"). "VS" should be designed to be more than minimum "VS". Otherwise the lamp may not be turned on because the lamp starting voltage is less than minimum "VS".

Example of measurement

Probe capacity: 3pF (Tektronix, inc. : P6015A)

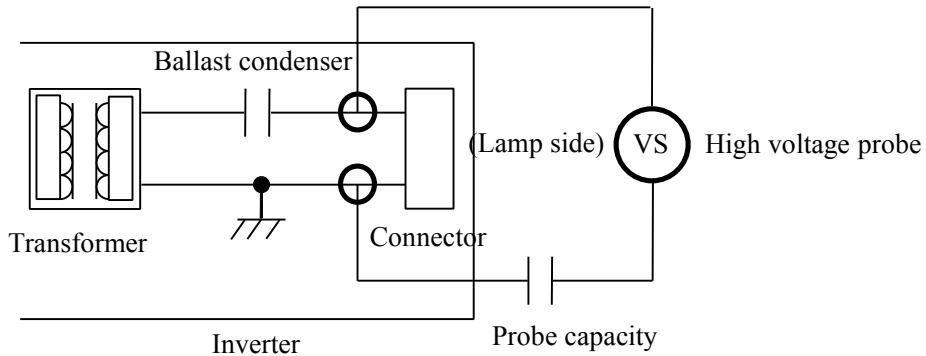

4.3.3 Power supply voltage ripple

This product works, even if the ripple voltage levels are beyond the permissible values as following the table, but there might be noise on the display image.

Power supply voltage		Ripple voltage (Measure at input terminal of power supply)	Note1	Unit
VCC	3.3V	↑ 100		mVp-p

Note1: The permissible ripple voltage includes spike noise.

4.3.4 Fuse

Parameter	Fuse		Rating	Fusing current	Remarks
	Type	Supplier			
VCC	FCC16202AB	KAMAYA ELECTRIC Co., Ltd	2.0A	4.0A	Note1
			32V		

Note1: The power supply capacity should be more than the fusing current. If it is less than the fusing current, the fuse may not blow in a short time, and then nasty smell, smoke and so on may occur.



4.4 POWER SUPPLY VOLTAGE SEQUENCE

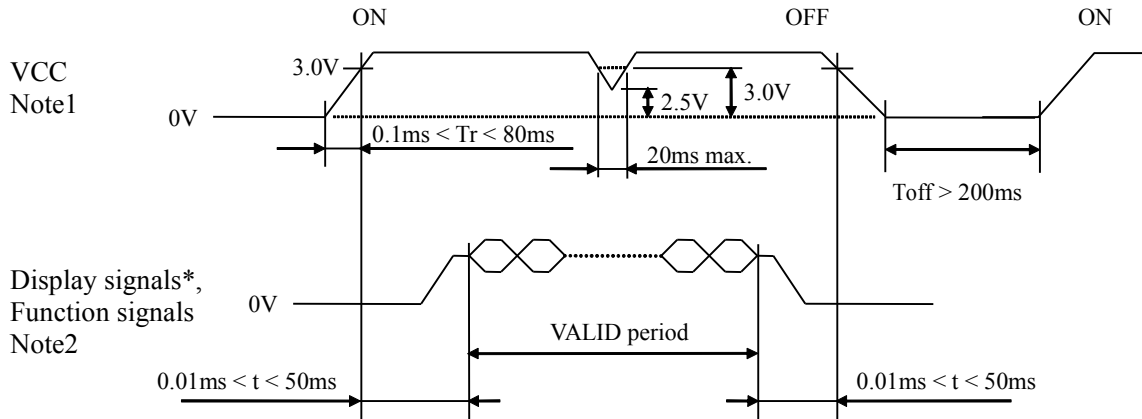

* These signals should be measured at the terminal of 100 Ω resistance.

Note1: In terms of voltage variation (voltage drop) while VCC rising edge is below 3.0V, a protection circuit may work, and then this product may not work.

Note2: Display signals (D0+/-, D1+/-, D2+/-, D3+/-, CLK+/-) and function signals (MSL, DPS) must be Low or High impedance, exclude the VALID period (See above sequence diagram), in order to avoid that internal circuit is damaged.

If some of display and function signals of this product are cut while this product is working, even if the signal input to it once again, it might not work normally. VCC should be cut when the display and function signals are stopped.

Note3: The backlight should be turned on within the valid period of display and function signals, in order to avoid unstable data display.



4.5 CONNECTIONS AND FUNCTIONS FOR INTERFACE PINS

4.5.1 LCD panel signal processing board

CN1 socket (LCD module side): DF14H-20P-1.25H (Hirose Electric Co., Ltd. (HRS))
 Adaptable plug: DF14-20S-1.25C (Hirose Electric Co., Ltd. (HRS))

Pin No.	Symbol	Signal	Remarks
1	VCC	Power supply	Note1
2	VCC		
3	GND	Ground	Note1
4	GND		
5	D0-	Pixel data	Note2
6	D0+		
7	GND	Ground	Note1
8	D1-	Pixel data	Note2
9	D1+		
10	GND	Ground	Note1
11	D2-	Pixel data	Note2
12	D2+		
13	GND	Ground	Note1
14	CLK-	Pixel clock	Note2
15	CLK+		
16	GND	Ground	Note1
17	D3-	Pixel data	Note2
18	D3+		
19	DPS	Selection of scan direction	High: Reverse scan Low or Open: Normal scan Note3, Note5
20	MSL	Selection of LVDS input map	High: Input map A Low or Open: Input map B Note4, Note5

Note1: All GND and VCC terminals should be used without any non-connected lines.

Note2: Twist pair wires with 100 Ω (Characteristic impedance) should be used between LCD panel signal processing board and LVDS transmitter.

Note3: See "**4.8 SCANNING DIRECTIONS**".

Note4: See "**4.5.4 Connection between receiver and transmitter for LVDS**".

Note5: This terminal is pulled-down in the product. (Pull-down resistance: 50k Ω)



4.5.2 Backlight lamp

Attention: VBLH and VBLC must be connected correctly. Wrong connections will cause electric shock and also break down of the product.

CN201 plug (LCD module side): BHR-03VS-1 (J.S.T Mfg. Co., Ltd.)
Adaptable socket: SM02(8.0)B-BHS-1-TB(LF)(SN), SM02(8.0)B-BHS-1-TB (J.S.T Mfg. Co., Ltd.)

Pin No.	Symbol	Signal	Remarks
1	VBLH	High voltage terminal (Hot)	Cable color: Pink
2	N.C.	-	Keep this pin Open.
3	VBLC	Low voltage terminal (Cold)	Cable color: Gray

CN202 plug (LCD module side): BHR-03VS-1 (J.S.T Mfg. Co., Ltd.)
Adaptable socket: SM02(8.0)B-BHS-1-TB(LF)(SN), SM02(8.0)B-BHS-1-TB (J.S.T Mfg. Co., Ltd.)

Pin No.	Symbol	Signal	Remarks
1	VBLH	High voltage terminal (Hot)	Cable color: Pink
2	N.C.	-	Keep this pin Open.
3	VBLC	Low voltage terminal (Cold)	Cable color: Gray

4.5.3 Positions of plug and socket

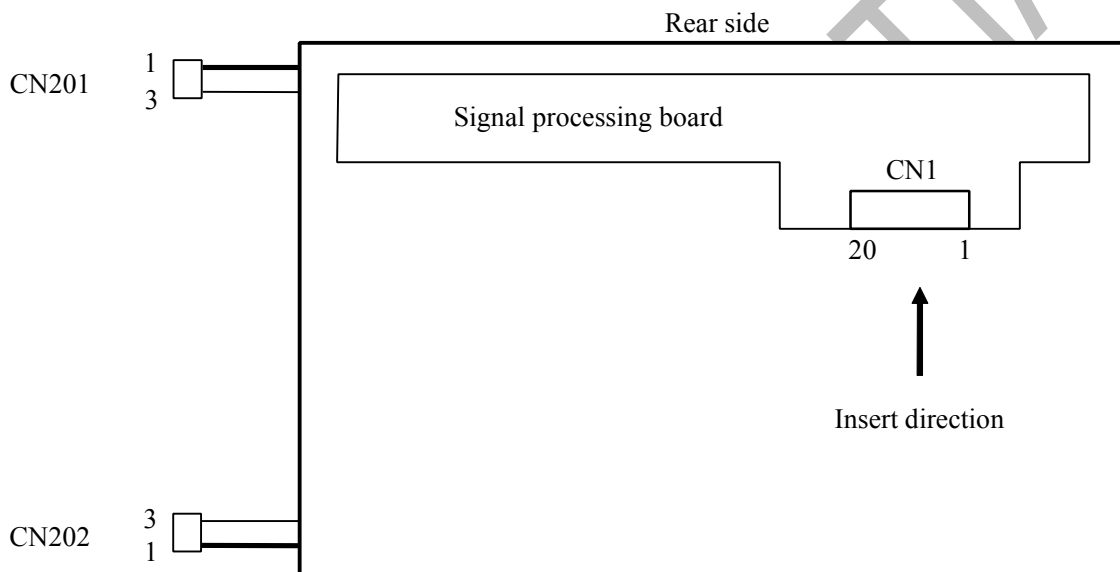



4.5.4 Connection between receiver and transmitter for LVDS

(1) Input LVDS map A (MSL: "High")

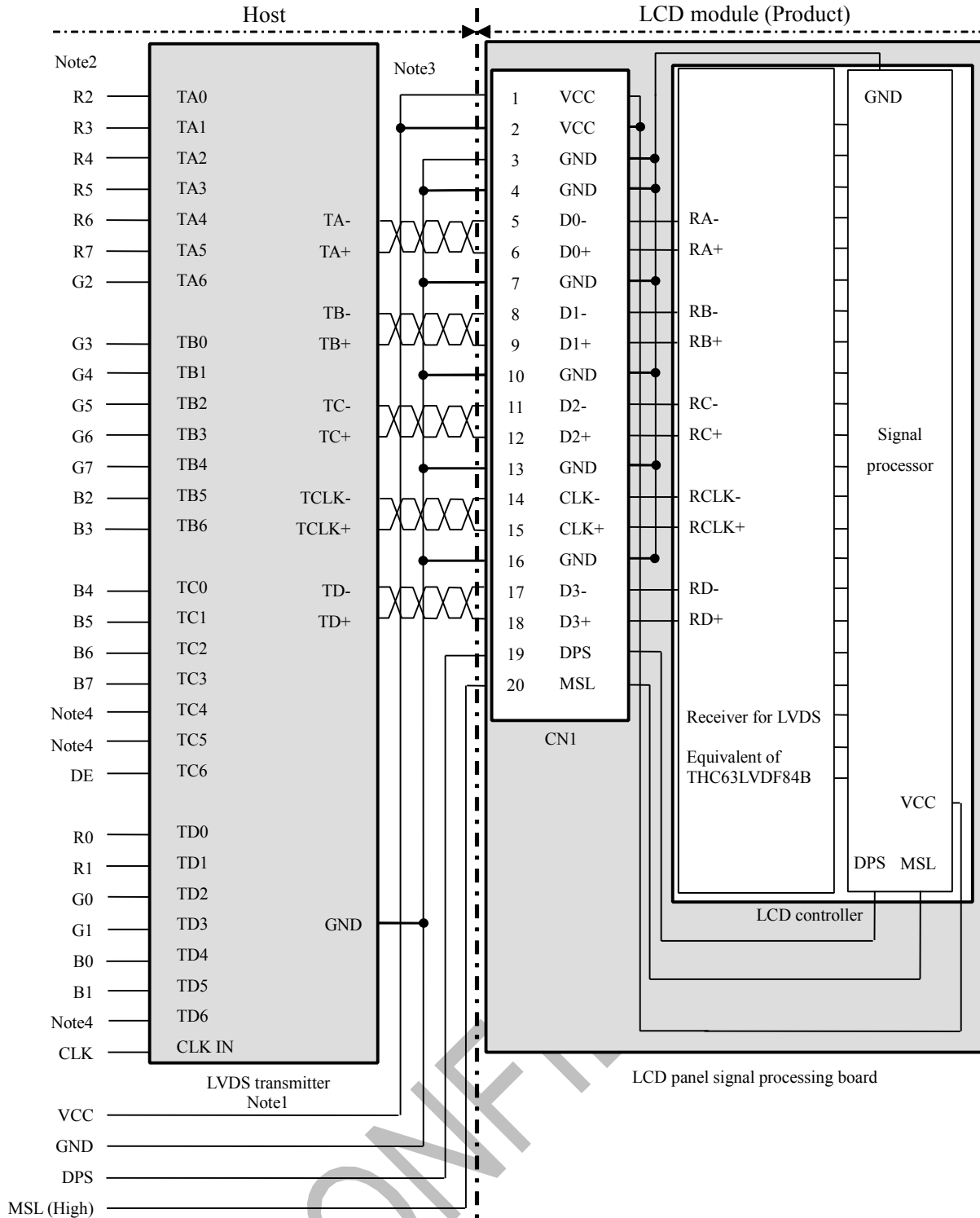



Note1: Recommended transmitter: THC63LVDM83R (THine Electronics Inc.) or equivalent

Note2: LSB (Least Significant Bit) – R0, G0, B0 MSB (Most Significant Bit) – R7, G7, B7

Note3: Twist pair wires with 100 Ω (Characteristic impedance) should be used between LCD panel signal processing board and LVDS transmitter.

Note4: Input signals to TC4, TC5 and TD6 are not used inside the product, but do not keep TC4, TC5 and TD6 open to avoid noise problem.



(2) Input LVDS map B (MSL: "Low" or "Open")

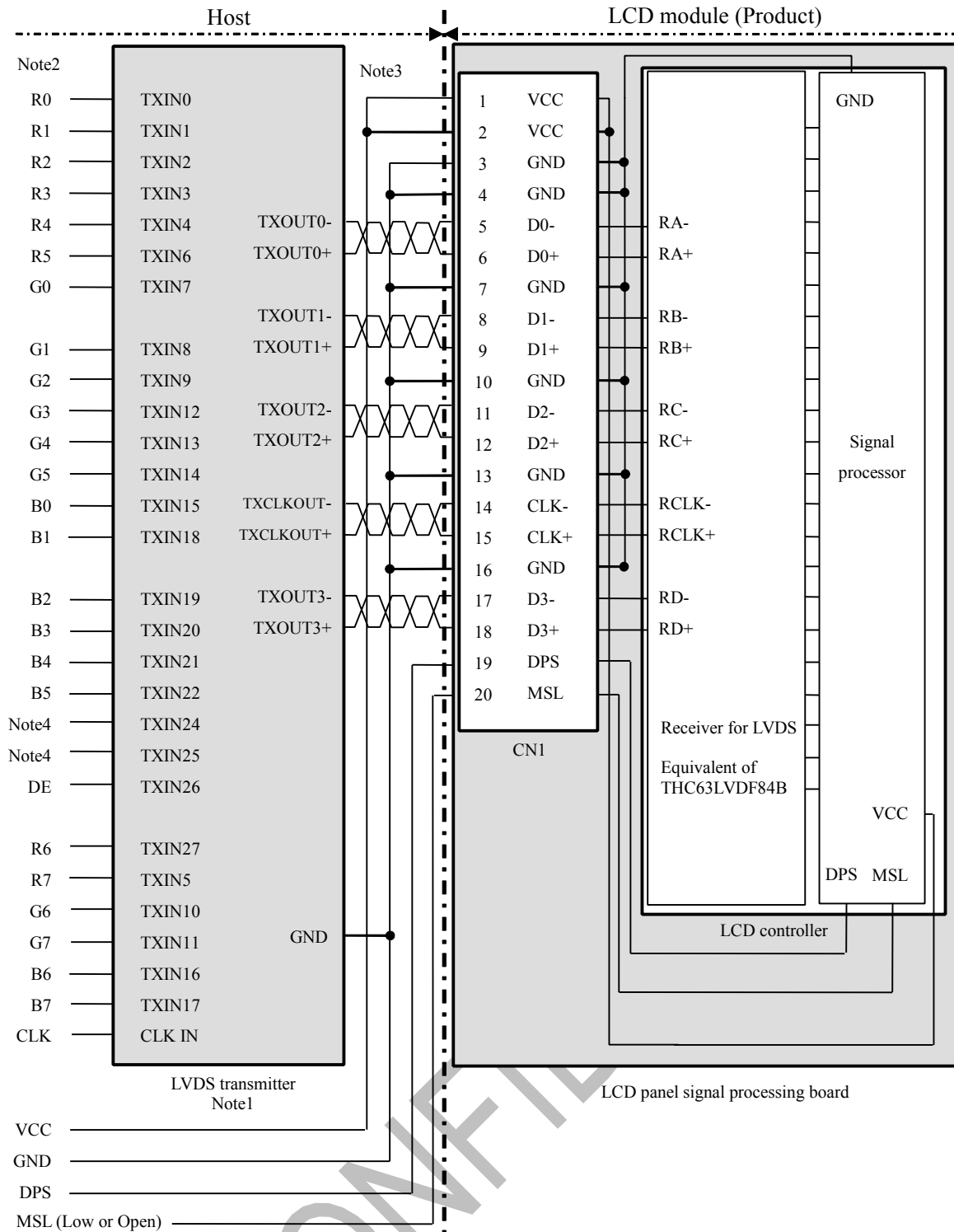



Note1: Recommended transmitter: DS90C383 (National Semiconductor) or equivalent

Note2: LSB (Least Significant Bit) – R0, G0, B0 MSB (Most Significant Bit) – R7, G7, B7

Note3: Twist pair wires with 100 Ω (Characteristic impedance) should be used between LCD panel signal processing board and LVDS transmitter.

Note4: Input signals to TXIN24 and TXIN25 are not used inside the product, but do not keep TXIN24 and TXIN25 open to avoid noise problem.



4.6 DISPLAY COLORS AND INPUT DATA SIGNALS

This product can display in equivalent to 16,777,216 colors in 256 gray scales. Also the relation between display colors and input data signals is as the following table.

Display colors		Data signal (0: Low level, 1: High level)																							
		R7	R6	R5	R4	R3	R2	R1	R0	G7	G6	G5	G4	G3	G2	G1	G0	B7	B6	B5	B4	B3	B2	B1	B0
Basic Colors	Black	0	0	0	0	0	0	0	0	0	0	0	0	0	0	0	0	0	0	0	0	0	0	0	0
	Blue	0	0	0	0	0	0	0	0	0	0	0	0	0	0	0	0	1	1	1	1	1	1	1	1
	Red	1	1	1	1	1	1	1	1	0	0	0	0	0	0	0	0	0	0	0	0	0	0	0	0
	Magenta	1	1	1	1	1	1	1	1	0	0	0	0	0	0	0	0	1	1	1	1	1	1	1	1
	Green	0	0	0	0	0	0	0	0	1	1	1	1	1	1	1	1	0	0	0	0	0	0	0	0
	Cyan	0	0	0	0	0	0	0	0	1	1	1	1	1	1	1	1	1	1	1	1	1	1	1	1
	Yellow	1	1	1	1	1	1	1	1	1	1	1	1	1	1	1	1	0	0	0	0	0	0	0	0
	White	1	1	1	1	1	1	1	1	1	1	1	1	1	1	1	1	1	1	1	1	1	1	1	1
Red gray scale	Black	0	0	0	0	0	0	0	0	0	0	0	0	0	0	0	0	0	0	0	0	0	0	0	0
		0	0	0	0	0	0	0	1	0	0	0	0	0	0	0	0	0	0	0	0	0	0	0	0
	dark	0	0	0	0	0	0	1	0	0	0	0	0	0	0	0	0	0	0	0	0	0	0	0	0
	▪				⋮																				
	·				⋮																				
	bright	1	1	1	1	1	1	0	1	0	0	0	0	0	0	0	0	0	0	0	0	0	0	0	0
Red	1	1	1	1	1	1	1	0	0	0	0	0	0	0	0	0	0	0	0	0	0	0	0	0	
Red	1	1	1	1	1	1	1	1	0	0	0	0	0	0	0	0	0	0	0	0	0	0	0	0	
Green gray scale	Black	0	0	0	0	0	0	0	0	0	0	0	0	0	0	0	0	0	0	0	0	0	0	0	0
		0	0	0	0	0	0	0	0	0	0	0	0	0	0	0	1	0	0	0	0	0	0	0	0
	dark	0	0	0	0	0	0	0	0	0	0	0	0	0	0	1	0	0	0	0	0	0	0	0	0
	▪				⋮																				
	·				⋮																				
	bright	0	0	0	0	0	0	0	0	1	1	1	1	1	1	0	1	0	0	0	0	0	0	0	0
Green	0	0	0	0	0	0	0	0	1	1	1	1	1	1	1	0	0	0	0	0	0	0	0	0	
Green	0	0	0	0	0	0	0	0	1	1	1	1	1	1	1	1	0	0	0	0	0	0	0	0	
Blue gray scale	Black	0	0	0	0	0	0	0	0	0	0	0	0	0	0	0	0	0	0	0	0	0	0	0	0
		0	0	0	0	0	0	0	0	0	0	0	0	0	0	0	0	0	0	0	0	0	0	0	1
	dark	0	0	0	0	0	0	0	0	0	0	0	0	0	0	0	0	0	0	0	0	0	0	1	0
	▪				⋮																				
	·				⋮																				
	bright	0	0	0	0	0	0	0	0	0	0	0	0	0	0	0	0	1	1	1	1	1	1	0	1
Blue	0	0	0	0	0	0	0	0	0	0	0	0	0	0	0	0	1	1	1	1	1	1	1	0	
Blue	0	0	0	0	0	0	0	0	0	0	0	0	0	0	0	0	1	1	1	1	1	1	1	1	



4.7 DISPLAY POSITIONS

The following table is the coordinates per pixel (See "4.8 SCANNING DIRECTIONS").

$C(0, 0)$

R	G	B
---	---	---

$C(0, 0)$	$C(1, 0)$	***	$C(X, 0)$	***	$C(1022, 0)$	$C(1023, 0)$
$C(0, 1)$	$C(1, 1)$	***	$C(X, 1)$	***	$C(1022, 1)$	$C(1023, 1)$
↑	↑	↑	↑	↑	↑	↑
↑	↑	***	↑	***	↑	***
↑	↑	↑	↑	↑	↑	↑
$C(0, Y)$	$C(1, Y)$	***	$C(X, Y)$	***	$C(1022, Y)$	$C(1023, Y)$
↑	↑	↑	↑	↑	↑	↑
↑	↑	***	↑	***	↑	***
↑	↑	↑	↑	↑	↑	↑
$C(0, 766)$	$C(1, 766)$	***	$C(X, 766)$	***	$C(1022, 766)$	$C(1023, 766)$
$C(0, 767)$	$C(1, 767)$	***	$C(X, 767)$	***	$C(1022, 767)$	$C(1023, 767)$

4.8 SCANNING DIRECTIONS

The following figures are seen from a front view. Also the arrow shows the direction of scan.

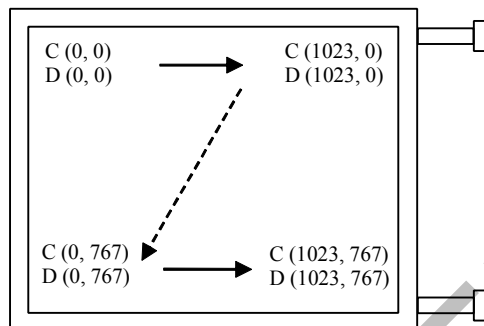

Figure1. Normal scan (DPS: Low or Open)

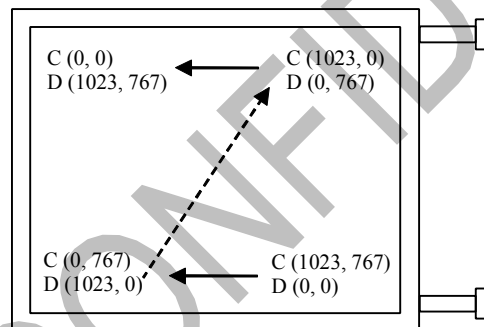

Figure2. Reverse scan (DPS: High)



Note1: Meaning of C (X, Y) and D (X, Y)

C (X, Y): The coordinates of the display position (See "**4.7 DISPLAY POSITIONS**".)

D (X, Y): The data number of input signal for LCD panel signal processing board



4.9 INPUT SIGNAL TIMINGS

4.9.1 Outline of input signal timings

- ◆ Horizontal signal
Note1

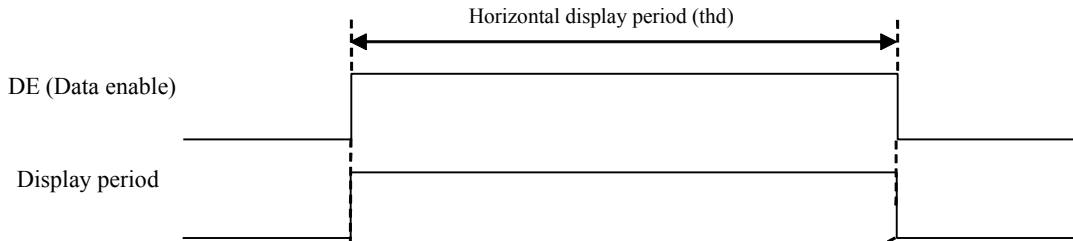

- ◆ Vertical signal
Note1

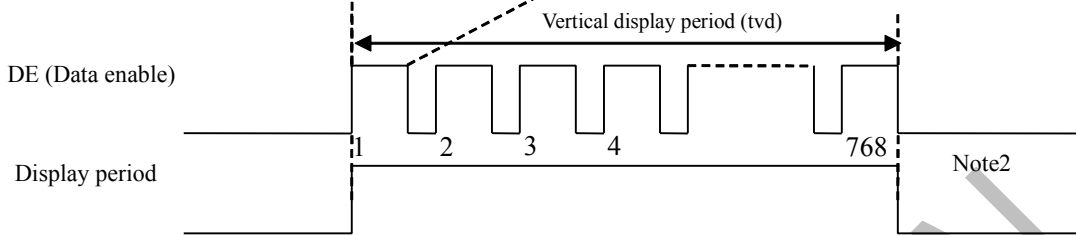

Note1: This diagram indicates virtual signal for set up to timing.

Note2: See "**4.9.3 Input signal timing chart**" for numeration of pulse.



4.9.2 Timing characteristics

(Note1, Note2, Note3)

Parameter		Symbol	min.	typ.	max.	Unit	Remarks	
CLK	Frequency	1/tc	50.0	65.0	80.0	MHz	15.384ns (typ.)	
	Duty	-	-			-	-	
	Rise time, Fall time	-	-			ns	-	
DATA	CLK-DATA	Setup time	-			ns	-	
		Hold time	-			ns		
	Rise time, Fall time	-	-			ns		
DE	Horizontal	Cycle	th	15	20.676	-	ns	48.363kHz (typ.)
				1,050	1,344	1,800	CLK	
		Display period	thd	1,024			CLK	-
	Vertical (One frame)	Cycle	tv	13.1	16.666	20.0	ms	60.000Hz (typ.)
				770	806	-	H	
		Display period	tvd	768			H	-
CLK-DE	Setup time	-	-			ns	-	
	Hold time	-	-			ns		
	Rise time, Fall time	-	-			ns		

Note1: Definition of parameters is as follows.

$$tc = 1\text{CLK}, th = 1H, Vf = 1/tv$$

Note2: See the data sheet of LVDS transmitter.

Note3: Vertical cycle (tv) should be specified in integral multiple of Horizontal cycle (th).



4.9.3 Input signal timing chart

Horizontal timing

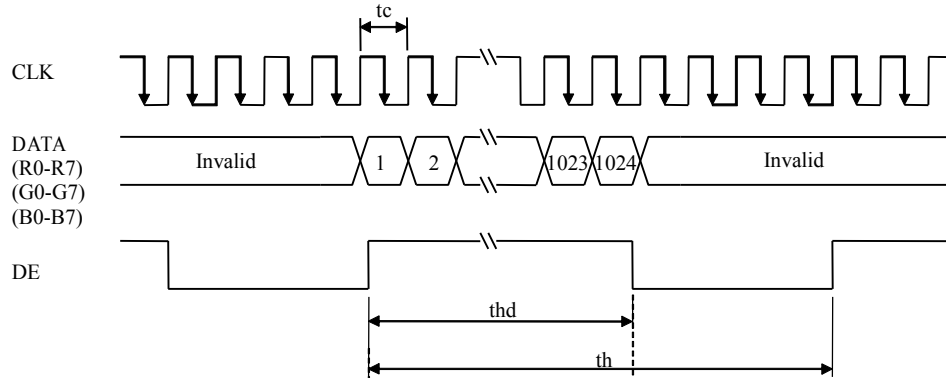

Vertical timing

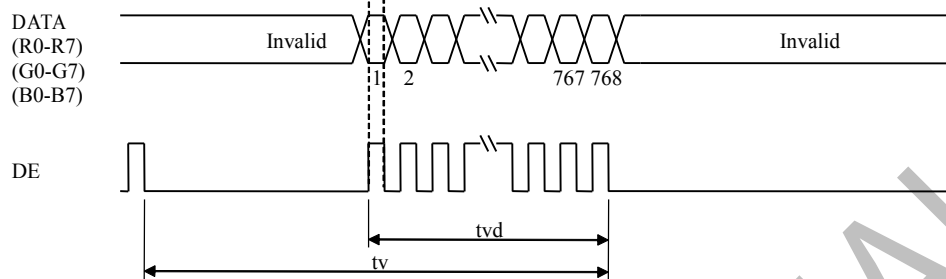



4.10 OPTICS

4.10.1 Optical characteristics

(Note1, Note2)

Parameter	Condition	Symbol	min.	typ.	max.	Unit	Measuring instrument	Remarks	
Luminance	White at center q R= 0→, L= 0→, U= 0→, D= 0→	L	200	250	-	cd/m ²	SR-3 or BM-5A	-	
Contrast ratio	White/Black at center q R= 0→, L= 0→, U= 0→, D= 0→	CR	350	500	-	-	SR-3 or BM-5A	Note3	
Luminance uniformity	White q R= 0→, L= 0→, U= 0→, D= 0→	LU	-	1.2	1.35	-	BM-5A	Note4	
Chromaticity	White	x coordinate	Wx	0.283	0.313	0.343	-	SR-3	Note5
		y coordinate	Wy	0.299	0.329	0.359	-		
	Red	x coordinate	Rx	-	0.62	-	-		
		y coordinate	Ry	-	0.35	-	-		
	Green	x coordinate	Gx	-	0.32	-	-		
		y coordinate	Gy	-	0.57	-	-		
Blue	x coordinate	Bx	-	0.15	-	-			
	y coordinate	By	-	0.12	-	-			
Color gamut	q R= 0→, L= 0→, U= 0→, D= 0→ at center, against NTSC color space	C	40	50	-	%			
Response time	White to Black	Ton	-	4	8	ms	BM-5A	Note6	
	Black to White	Toff	-	14	22	ms		Note7	
Viewing angle	Right	q U= 0→, q D= 0→, CR= 10	q R	70	80	-	BM-5A or EZ Contrast	Note8	
	Left	q U= 0→, q D= 0→, CR= 10	q L	70	80	-			
	Up	q R= 0→, q L= 0→, CR= 10	q U	70	80	-			
	Down	q R= 0→, q L= 0→, CR= 10	q D	70	80	-			

Note1: These are initial characteristics.

Note2: Measurement conditions are as follows.

Ta= 25→C, VCC= 3.3V, IBL= 7.5mArms/lamp, Display mode: XGA,
Horizontal cycle= 1/48.363kHz, Vertical cycle= 1/60.0Hz, DPS= Low or Open: Normal scan

Optical characteristics are measured at luminance saturation after 20minutes from working the product, in the dark room. Also measurement methods are as follows.

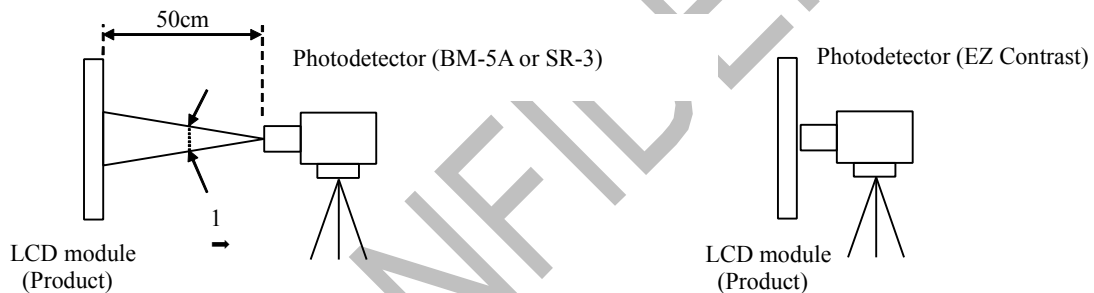

Note3: See "4.10.2 Definition of contrast ratio".

Note4: See "4.10.3 Definition of luminance uniformity".

Note5: These coordinates are found on CIE 1931 chromaticity diagram.



Note6: Product surface temperature: TopF= 32→C

Note7: See "4.10.4 Definition of response times".

Note8: See "4.10.5 Definition of viewing angles".

4.10.2 Definition of contrast ratio

The contrast ratio is calculated by using the following formula.

Contrast ratio (CR) = Luminance of white screen / Luminance of black screen

4.10.3 Definition of luminance uniformity

The luminance uniformity is calculated by using following formula.

Luminance uniformity (LU) = Maximum luminance from ① to ⑤ / Minimum luminance from ① to ⑤

The luminance is measured at near the 5 points shown below.

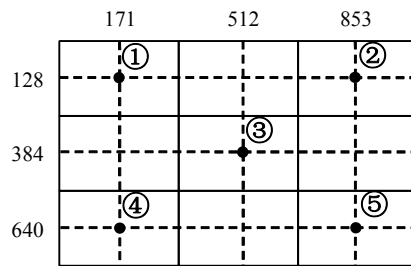

4.10.4 Definition of response times

Response time is measured, the luminance changes from "white" to "black", or "black" to "white" on the same screen point, by photo-detector. Ton is the time it takes the luminance change from 90% down to 10%. Also Toff is the time it takes the luminance change from 10% up to 90% (See the following diagram.).

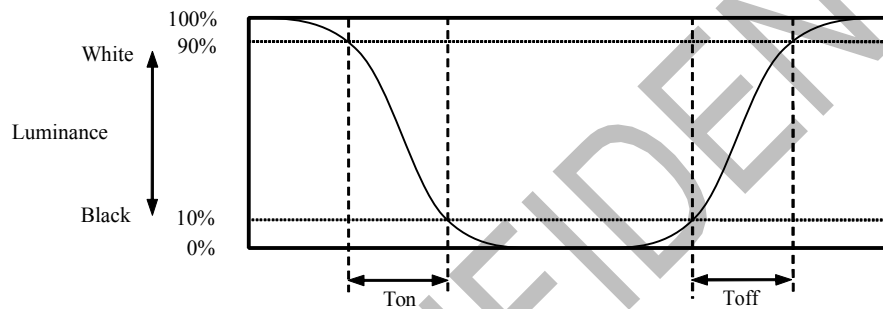

4.10.5 Definition of viewing angles

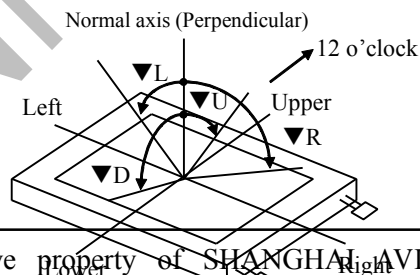

The information contained herein is the exclusive property of SHANGHAI AVIC OPTOELECTRONICS Corporation, and shall not be distributed, reproduced, or disclosed in whole or in part without prior written permission of SHANGHAI AVIC OPTOELECTRONICS Corporation.



AVIC CONFIDENTIAL



4.11 DEFECT CRITERIA

4.11.1 Display specifications

Defect pattern	Condition			Criteria	Note1
Line defect	Display of black , white, red, green, blue			0 line	
Bright dots Note2, Note3	Red + Green + Blue			↑ 3 dots	
	Close defect dots Note5	0mm < D ↑ 15mm Note7		Same color and different color	0 set
	Linked defect dots Note6	D = 0mm Note7	2 defect dots	Same color	0 set
			3 defect dots or more	Different color	↑ 1 set
Dark dots Note2, Note4	Red + Green + Blue			↑ 3 dots	
	Close defect dots Note5	0mm < D ↑ 15mm Note7		Same color and different color	0 set
	Linked defect dots Note6	D = 0mm Note7	2 defect dots	Same color and different color	0 set
			3 defect dots or more	Same color and different color	
Between Bright dots and Dark dots	Close defect dots Note5	0mm < D ↑ 15mm Note7		Same color and different color	Allowed
	Linked defect dots Note6	D = 0mm Note7	2 defect dots	Same color and different color	Allowed
			3 defect dots or more	Same color and different color	0 set
Total	Bright dots + Dark dots			↑ 6 dots	

Note1: Inspection conditions are as follows.

Temperature	25 ± 5 °C
Inspection viewing distance	20cm (The distance between the inspector's eye and screen.)
Inspection direction	0 → ↑ ▼ R ↑ 20 →, 0 → ↑ ▼ L ↑ 20 →
	0 → ↑ ▼ U ↑ 20 →
Inspection illumination	60lx (at a display surface)

Note2: Regardless of bright or intermittent bright, 1/3 or more defects of a dot area is counted as the defect dot.

Note3: Bright dots are counted while the display is black.

Note4: Dark dots are counted while the display is illuminated with Red, Green or Blue.

Note5: See "4.11.2 Close defect dots".

Note6: See "4.11.3 Linked defect dots".

Note7: **D** is the distance between defect dots.





4.11.2 Close defect dots

Defect pattern	: Bright dot : Dark dot	Criteria
Bright dots	Same color and different color $0\text{ mm} < \mathbf{D} \uparrow 15\text{mm}$	0 set
Dark dots	Same color and different color $0\text{ mm} < \mathbf{D} \uparrow 15\text{mm}$	
Combination between bright dot and dark dot	$0\text{ mm} < \mathbf{D} \uparrow 15\text{mm}$	Allowed

4.11.3 Linked defect dots

Defect pattern	: Bright dot : Dark dot	Criteria
2 defect dots	Same color 	0 set
	Different color 	\uparrow 1 set
	Same color and different color 	0 set
	Combination between bright dot and dark dot 	Allowed

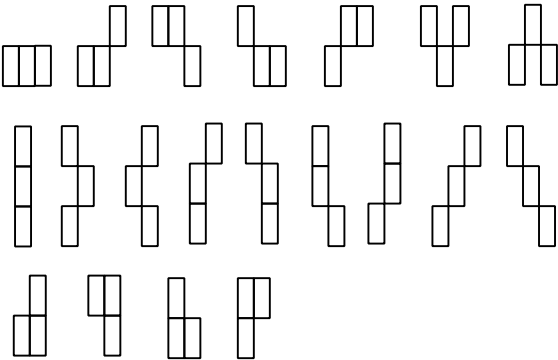
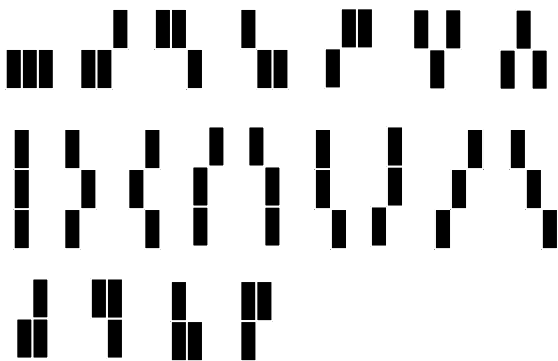
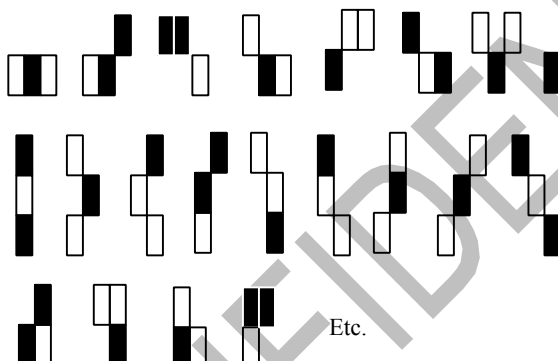

Defect pattern	 : Bright dot  : Dark dot	Criteria
3 defect dots	<p>Bright dot</p> 	0 set
	<p>Dark dots</p> 	
	<p>Combination between bright dot and dark dot</p>  <p>Etc.</p>	



4.11.4 Appearance specifications

Defect pattern		Condition	Note1	Criteria	Note2
Impure ingredient Stains Dust	Dot shape	d < 0.2 mm		Allowed	
		0.2mm ↑ d < 0.3mm		↑ 10 points	
		0.3mm ↑ d ↑ 0.5mm		↑ 3 points	
		d > 0.5 mm		0 point	
	Line shape	W < 0.05mm		Allowed	
		0.05mm ↑ W ↑ 0.1mm	L < 0.7 mm	↑ 4 points	
			0.7mm ↑ L ↑ 1.0mm		
L > 1.0mm		0 point			
		W > 0.1mm			
Bubbles, Wrinkles, Dent		d ↑ 0.2mm		Allowed	
		0.2mm < d ↑ 0.5mm		↑ 2 points	
		d > 0.5 mm		0 point	
Scratch (Surface of polarizer)		S ↑ 0.2 mm ²		Allowed	
		S > 0.2 mm ²		0 point	

Note1: Definition of symbols is as follows.

d: Average diameter

(This diameter is the average length of a long axis and a short axis in each defect pattern.)

W: Width, L: Length, S: Area

Note2: Inspection conditions are as follows.

Temperature	25 ± 5→C
Inspection viewing distance	20cm (The distance between the inspector's eye and screen.)
Inspection direction	0→ ↑▼R↑ 45→, 0→ ↑▼L↑ 45→
	0→ ↑▼U↑ 45→, 0→ ↑▼D↑ 45→
Illumination	700lx (at an inspection desk surface)



5. ESTIMATED LUMINANCE LIFETIME

The luminance lifetime is the time from initial luminance to half-luminance.

This lifetime is the estimated value, and is not guarantee value.

Condition		Luminance lifetime (MTTF) Note1, Note2	Unit
Module	25→C (Ambient temperature of the product) Continuous operation, IBL= 7.5mArms/lamp	40,000	h
	70→C (Surface temperature at screen center) Continuous operation, IBL= 7.5mArms/lamp	30,000	h
Cold cathode fluorescent lamp	25→C (Ambient temperature of the lamp) Continuous operation, IBL= 7.5mArms	50,000	h

Note1: MTTF is mean time to half-luminance.

Note2: In case the product works under low temperature environment, the lifetime becomes short.

6. MARKINGS

The various markings are attached to this product. See "11. OUTLINE DRAWINGS" for attachment positions.

6.1 NAMEPLATE LABEL

Nameplate label

Note1: The meaning of lot number

◆ Example: A0710036

A	0	7	10036
Revision 1 letter (Alphabet)	Manufacturing year 1 figure of the A.D. end numbers (e.g.: A.D 2010 is 0.)	Manufacturing month 1 letter (Jan. to Sep.: Number of month October: A November: B December: C)	Production number Multi-letter

Note2: **Do not attach anything such as label and so on, on the nameplate!** In case repair the product, AVIC needs the contents of nameplate such as the lot number, inspection date and so on, to identify the warranty period with individual product. If AVIC cannot decipher the contents of nameplate, such repair shall be entitled to charge. Also AVIC may give a new lot number to repair products.



6.2 BARCODE LABEL

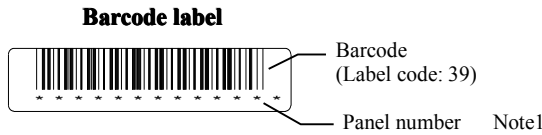

Note1: The same panel number is given to barcode label and nameplate label.

6.3 OTHER MARKINGS

High voltage caution marking

Disposal method marking for lamp

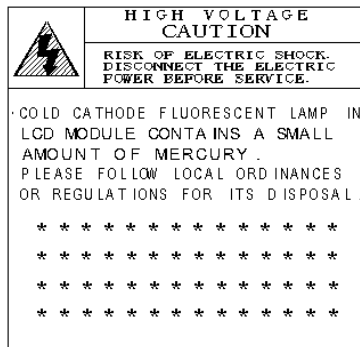

**Material information marking
for light guide plate**

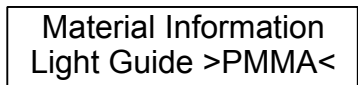



7. PACKING, TRANSPORTATION AND DELIVERY

AVIC will pack products to deliver to customer in accordance with AVIC's packing specifications, and will deliver products to customer in such a condition that products will not suffer from a damage during transportation. The delivery conditions are as follows.

7.1 INNER PACKING BOX

10 products are packed as the maximum in an inner packing box (See "**9.6 OUTLINE FIGURE FOR PACKING**"). The type name and quantity are shown on outside of the inner packing box, either labeling or printing. In case the inner packing box with products is dropped from a height of 60cm or more, there is a risk of damage to products.

In case of shipping the product out of Japan, the product must not be transported only with the inner box, because there is a high risk of damage. Be sure to use an outer packing box which is shown below!

7.2 OUTER PACKING BOX

The inner box with products is packed in an outer packing box (See "**9.6 OUTLINE FIGURE FOR PACKING**"). The type name and quantity are shown on outside of the outer packing box, either labeling or printing. In case the outer packing box with products is dropped from a height of 60cm or more, there is a risk of damage to products.

Outer packing box is used only when shipping the product out of Japan.

7.3 INSPECTION RECORD SHEET

Inspection record sheets are included in an inner packing box with products. It is summarized to a number of products for pass/fail assessment.

7.4 TRANSPORTATION

The product is transported by vehicle, aircraft or ship.

7.5 SIZE AND WEIGHT FOR PACKING BOXES

Parameter	Inner packing box	Outer packing box	Unit
Size	438 ▶ 402 ▶ 464 (typ.)	463 ▶ 429 ▶ 511 (typ.)	mm
Weight	TBD (typ.)	TBD (typ.)	kg
Total weight	TBD(typ.) (with 10 products)	TBD (typ.) (with an inner packing box and 10 products)	kg



7.6 OUTLINE FIGURE FOR PACKING

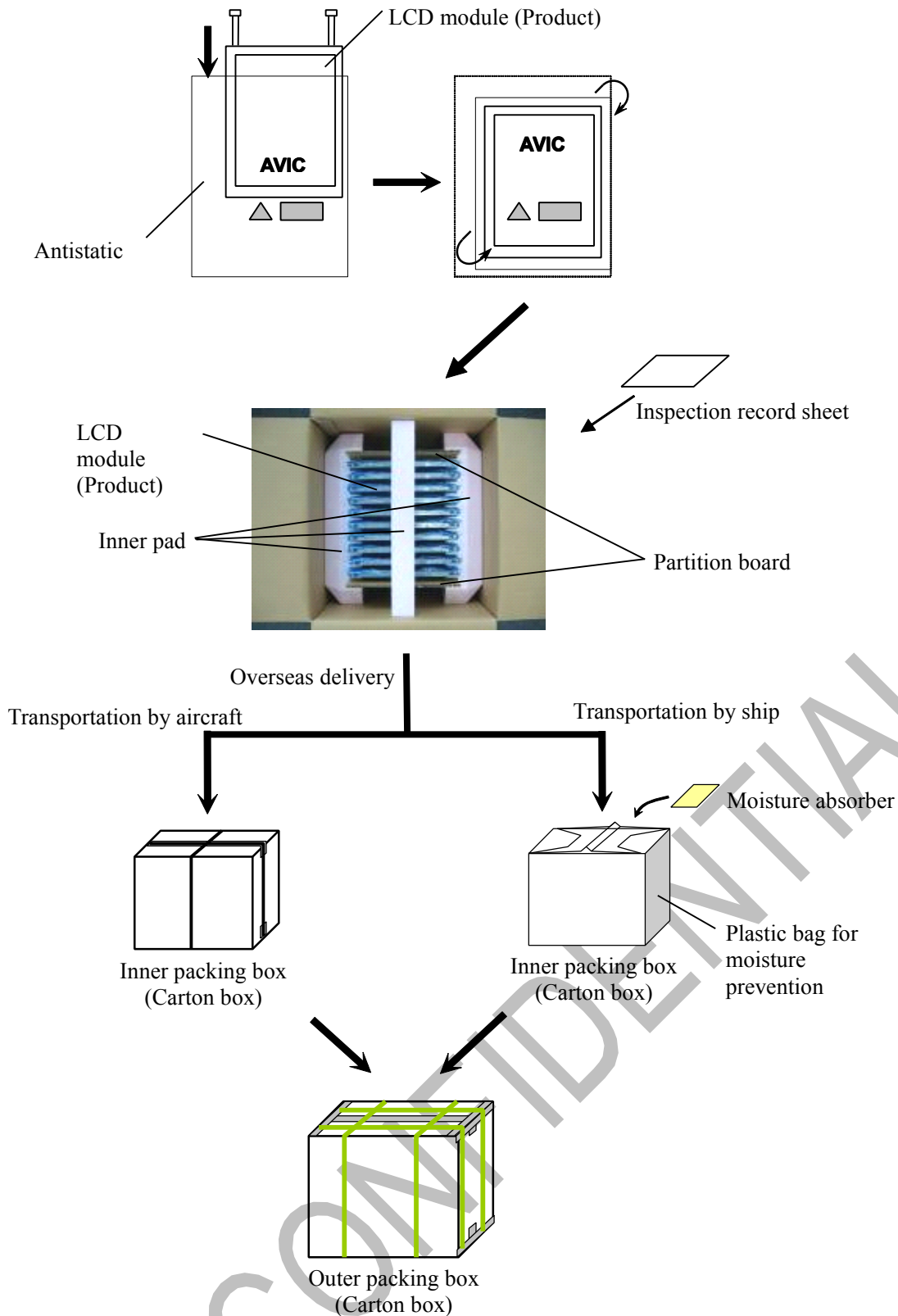



8. PRECAUTIONS

8.1 MEANING OF CAUTION SIGNS

The following caution signs have very important meaning. **Be sure to read "10.2 CAUTIONS" and "10.3 ATTENTIONS", after understanding these contents!**



This sign has the meaning that customer will be injured by himself or the product will sustain a damage, if customer has wrong operations.



This sign has the meaning that customer will get an electrical shock, if customer has wrong operations.



This sign has the meaning that customer will be injured by himself, if customer has wrong operations.

8.2 CAUTIONS



→ **Do not touch the working backlight. There is a danger of an electric shock.**



→ **Do not touch the working backlight. There is a danger of burn injury.**
 → **Do not shock and press the LCD panel and the backlight! There is a danger of breaking, because they are made of glass. (Shock: To be not greater 294m/s² and to be not greater 11ms, Pressure: To be not greater 19.6 N (←16mm jig))**

8.3 ATTENTIONS



8.3.1 Handling of the product

- ① Take hold of both ends without touching the circuit board when the product (LCD module) is picked up from inner packing box to avoid broken down or misadjustment, because of stress to mounting parts on the circuit board.
- ② Do not hook nor pull cables such as lamp cable, and so on, in order to avoid any damage.
- ③ When the product is put on the table temporarily, display surface must be placed downward.
- ④ When handling the product, take the measures of electrostatic discharge with such as earth band, ionic shower and so on, because the product may be damaged by electrostatic.
- ⑤ The torque for product mounting screws must never exceed 0.343N·m. Higher torque might result in distortion of the bezel. And the length of product mounting screws must be ↑ 2.8mm.
- ⑥ The product must be installed using mounting holes without undue stress such as bends or twist (See outline drawings). And do not add undue stress to any portion (such as bezel flat area). Bends or twist described above and undue stress to any portion may cause display mura.
- ⑦ **Do not press or rub on the sensitive product surface. When cleaning the product surface, use of the cloth with ethanolic liquid such as screen cleaner for LCD is recommended.**
- ⑧ Do not push nor pull the interface connectors while the product is working.
- ⑨ Do not bend or unbend the lamp cable at the near part of the lamp holding rubber, to avoid the damage for high voltage side of the lamp.

The information contained herein is the exclusive property of SHANGHAI AVIC OPTOELECTRONICS Corporation, and shall not be distributed, reproduced, or disclosed in whole or in part without prior written permission of SHANGHAI AVIC OPTOELECTRONICS Corporation.



- ⑩ Properly connect the plug (backlight side) to adaptable socket (inverter side) without incomplete connection. After connecting, be careful not to hook the lamp cables because incomplete connection may occur by hooking the lamp cables. This incomplete connection may cause abnormal operation of high voltage circuit.

If the lamp cable is attached on the metal part of the product directly, high frequency leak current to the metal part may occur, then the brightness may decrease or the lamp may not be turned on.

When handling the product, use of an original protection sheet on the product surface (polarizer) is recommended for protection of product surface. Adhesive type protection sheet may change color or characteristics of the polarizer.

Usually liquid crystals don't leak through the breakage of glasses because of the surface tension of thin layer and the construction of LCD panel. But, if you contact with liquid crystal for the worst, please wash it out with soap.

8.3.2 Environment

- ① Do not operate or store in high temperature, high humidity, dewdrop atmosphere or corrosive gases. Keep the product in packing box with antistatic pouch in room temperature to avoid dusts and sunlight, when storing the product.
- ② In order to prevent dew condensation occurring by temperature difference, the product packing box should be opened after enough time being left under the environment of an unpacking room. Evaluate the leaving time sufficiently because a situation of dew condensation occurring is changed by the environmental temperature and humidity. (Recommended leaving time: 6 hours or more with packing state)
- ③ Do not operate in high magnetic field. Circuit boards may be broken down by it.
- ④ This product is not designed as radiation hardened.

8.3.3 Characteristics

The following items are neither defects nor failures.

- ① Response time, luminance and color may be changed by ambient temperature.
- ② Display mura, flicker, vertical seam or small spot may be observed depending on display patterns.
- ③ Optical characteristics (e.g. luminance, display uniformity, etc.) gradually is going to change depending on operating time, and especially low temperature, because the LCD has cold cathode fluorescent lamps.
- ④ Do not display the fixed pattern for a long time because it may cause image sticking. Use a screen saver, if the fixed pattern is displayed on the screen.
- ⑤ The display color may be changed depending on viewing angle because of the use of condenser sheet in the backlight.
- ⑥ Optical characteristics may be changed depending on input signal timings.
- ⑦ The interference noise between input signal frequency for this product's signal processing board and luminance control frequency of the inverter may appear on a display. Set up luminance control frequency of the inverter so that the interference noise does not appear.
- ⑧ After the product is stored under condition of low temperature or dark place for a long time, the cold cathode fluorescent lamp may not be turned on under the same condition because of the general characteristic of cold cathode fluorescent lamp. In addition, when Luminance control ratio is low in pulse width modulation method inverter, the lamp may not be turned on. In this case, power should be supplied again.



8.3.4 Other

- ① All GND and VCC terminals should be used without any non-connected lines.
- ② Do not disassemble a product or adjust variable resistors.
- ③ See "REPLACEMENT MANUAL FOR LAMP HOLDER SET", when replacing backlight lamps.
- ④ Pack the product with original shipping package, in order to avoid any damages during transportation, when returning the product to AVIC for repair and so on.
- ⑤ The information of China RoHS directive six hazardous substances or elements in this product is as follows.

China RoHS directive six hazardous substances or elements					
Lead (Pb)	Mercury (Hg)	Cadmium (Cd)	Hexavalent Chromium (Cr VI)	Polybrominated Biphenyls (PBB)	Polybrominated Biphenyl Ethers (PBDE)

Note1: : This indicates that the poisonous or harmful material in all the homogeneous materials for this part is equal or below the limitation level of SJ/T11363-2006 standard regulation.
 : This indicates that the poisonous or harmful material in all the homogeneous smaterials for this part is above the limitation level of SJ/T11363-2006 standard regulation.

AVIC CONFIDENTIAL

9. OUTLINE DRAWINGS

9.1 FRONT VIEW

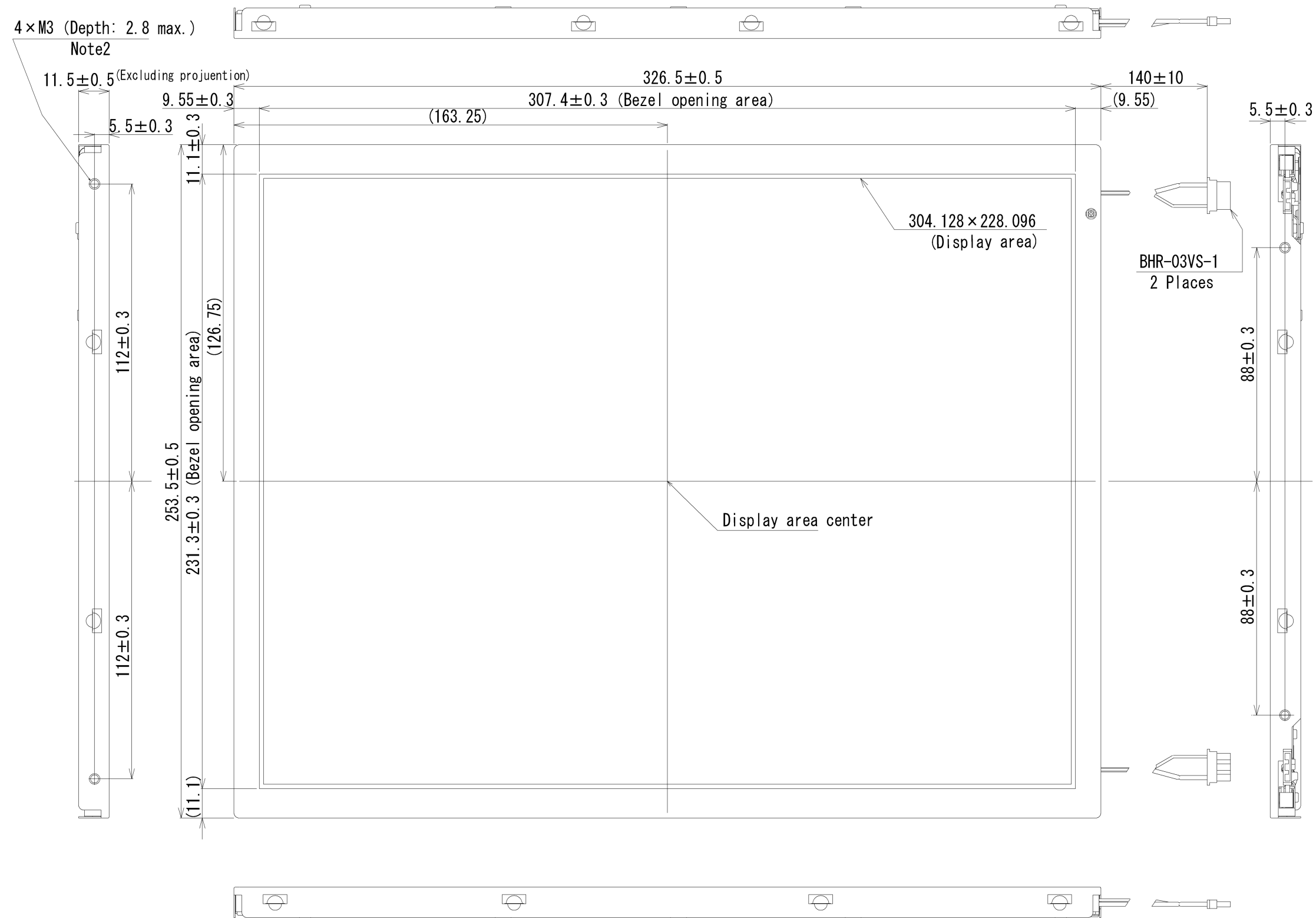

Unit: mm

9.2 REAR VIEW

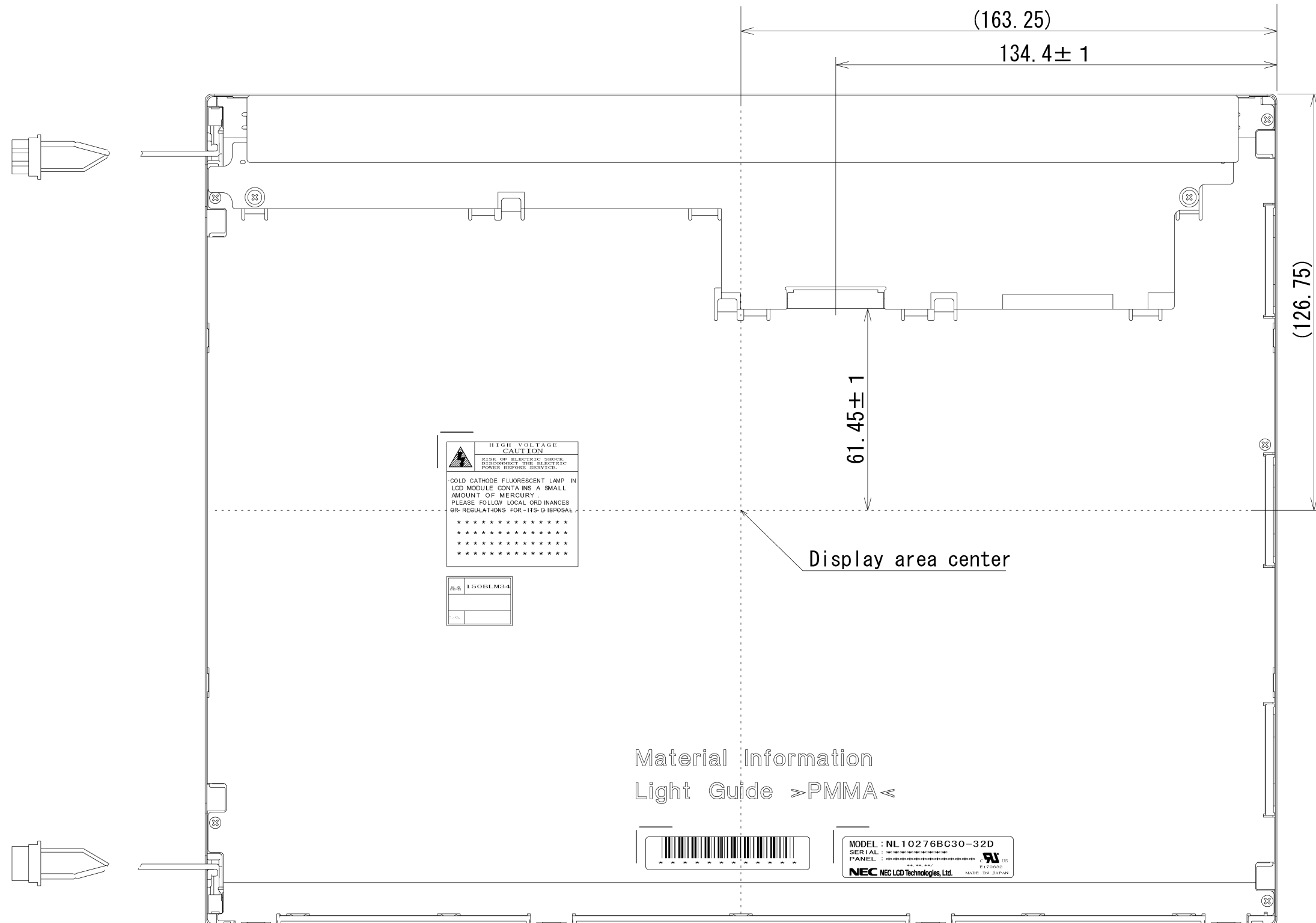

Note1: The values in parentheses are for reference.

Unit: mm