



TIANMA

SPECIFICATION FOR LCD MODULE

CUSTOMER:	TM Standard LCM
CUSTOMER NO.:	-----
PRODUCT NO.:	TM320240EGFWVSWD
PRODUCT TYPE:	Graphic Matrix STN
VERSION:	1.0

Preliminary specification

Final specification

CUSTOMER APPROVED	
-------------------	--

PREPARED BY	CHECKED BY	VERIFIED BY QA DEPT.	APPROVED BY
刘永勇 1/2-08	姚文 1/2-08	唐银峰 1/2-08	徐四海 1/2-08

TIANMA CHINA:
 TEL: (86-755) 83790774
 FAX: (86-755) 83790431
www.tianma.com

TIANMA USA:
 TEL: (86-755) 83790774
 FAX: (86-755) 83790431
www.tianma.com.cn

TIANMA EUROPE:
 TEL: +49-721-983110-0
 FAX: +49-721-983110-20
www.tianma-europe.com

TIANMA MICROELECTRONICS CO., LTD

Company confidential. Duplication or disclosure prohibited. All rights reserved



REVISION RECORD

Version	Page	Revision Items	Name	Date
1.0		First release	Jiayong Liu	2008.1.15

TABLE OF CONTENTS

1 Description.....	3
2 Features.....	3
3 Absolute maximum ratings	4
4 Mechanical Characteristics.....	4
4.1 Mechanical features	4
4.2 Mechanical drawing.....	5
5 Circuit	6
5.1 Block Diagram.....	6
5.2 Recommend power supply circuit	7
6 Interface description	8
7 Instruction Code & Timing characteristics	9
7.1 Command and initial code	9
7.2 Interface Timing characteristics.....	10
7.3 Data and picture mapping	11
8 Electrical characteristics	12
9 LED backlight characteristics.....	12
10 Optical Characteristics.....	13
11 Reliability.....	16
11.1 Content of Reliability Test	16
11.2 Inspection of criteria	17
12 Package	17
13 Quality level.....	18
14 Precautions for Use of LCD Modules.....	18
14.1 Handling Precautions	18
14.2 Storage precautions	19
14.3 Transportation precautions.....	19
14.4 Soldering.....	19
15. LCD Module Part Numbering System.....	20
Appendix A	21
Appendix B	23

1 Description

The TM320240EGFWVSWD, a Graphic LCM unit consists of 320(segment)×240(common) dots dot-matrix LCD panel, LCD driver and controller, bias circuits on a single PCB. Incorporating mask ROM-based character generator and display data RAM in the controller LSI, the unit can efficiently display the desired dot-matrix under microprocessor control.

- ◆ Wide viewing angle
- ◆ Wide operation temp.
- ◆ Built-in DC-DC and temp. Compensation circuits.
- ◆ Built-in character generator
- ◆ Requirements on environmental protection: RoHS.

2 Features

Item	Contents
LCD type	FSTN
	Negative
LCD Duty	1/240
LCD Bias	1/16
Polarizer	Transmissive
LCD background color	Blue-black
Segment color	White
Backlighting	LED
Backlighting type	Side
Backlighting color	White
View direction	6:00
Operating temperature	-20°C~70°C
Storage temperature	-30°C~80°C
LCD Controller	S1D13700
Frame	SUS430
Technology	SMT
Data Transfer	8 Bit Parallel

3 Absolute maximum ratings

(VSS=0V, Ta=25°C)

Parameter	Symbol	Min	Max	Unit	Remark
Logic circuit supply voltage	V _{DD}	-0.3	+6.0	V	---
Input voltage of logic control or data pins	V _I	-0.3	V _{DD} +0.3	V	---
Voltage of V ₀	V ₀	-24	0.3	V	---
Voltage of V _{EE}	V _{EE}	-24	0.3	V	---
LCD driving voltage	V _{LCD}	-0.3	28.5	V	Note [3-2]
Operating temperature range	T _{OP}	-20	+70	°C	Note [3-3]
Storage temperature range	T _{ST}	-30	+80	°C	

Note [3-1]: No parameter is allowed to exceed these maximum ratings.

Note [3-2]: LCD operating voltage is calculated as V_{LCD}=V_{DD}-V_S.

Note [3-3]: 95% RH MAX (40 °C ≥ Ta);

Maximum wet-bulb temperature is 39°C or less. (Ta >40 °C) No dew condensation.

Note [3-4]: Only operation is guaranteed at operating temperature. Contrast, response time and another display quality are evaluated at +25°C.

4 Mechanical Characteristics

4.1 Mechanical features

Parameter	Standard Value	Unit
Display type	Graphics Matrix LCM	--
Character size(W×H)	--	mm
Number of dots	320 x 240	--
View area (W×H)	119.8 x 90.6	mm
Active Area (W×H)	115.17 x 86.37	mm
Dot Size (W×H)	0.33 x 0.33	mm
Dot Pitch (W×H)	0.36 x 0.36	mm
Module size(W×H×D)	160.0 x 109.0 x 14.0(MAX)	mm
Module total weight (approx)	230	g

4.2 Mechanical drawing

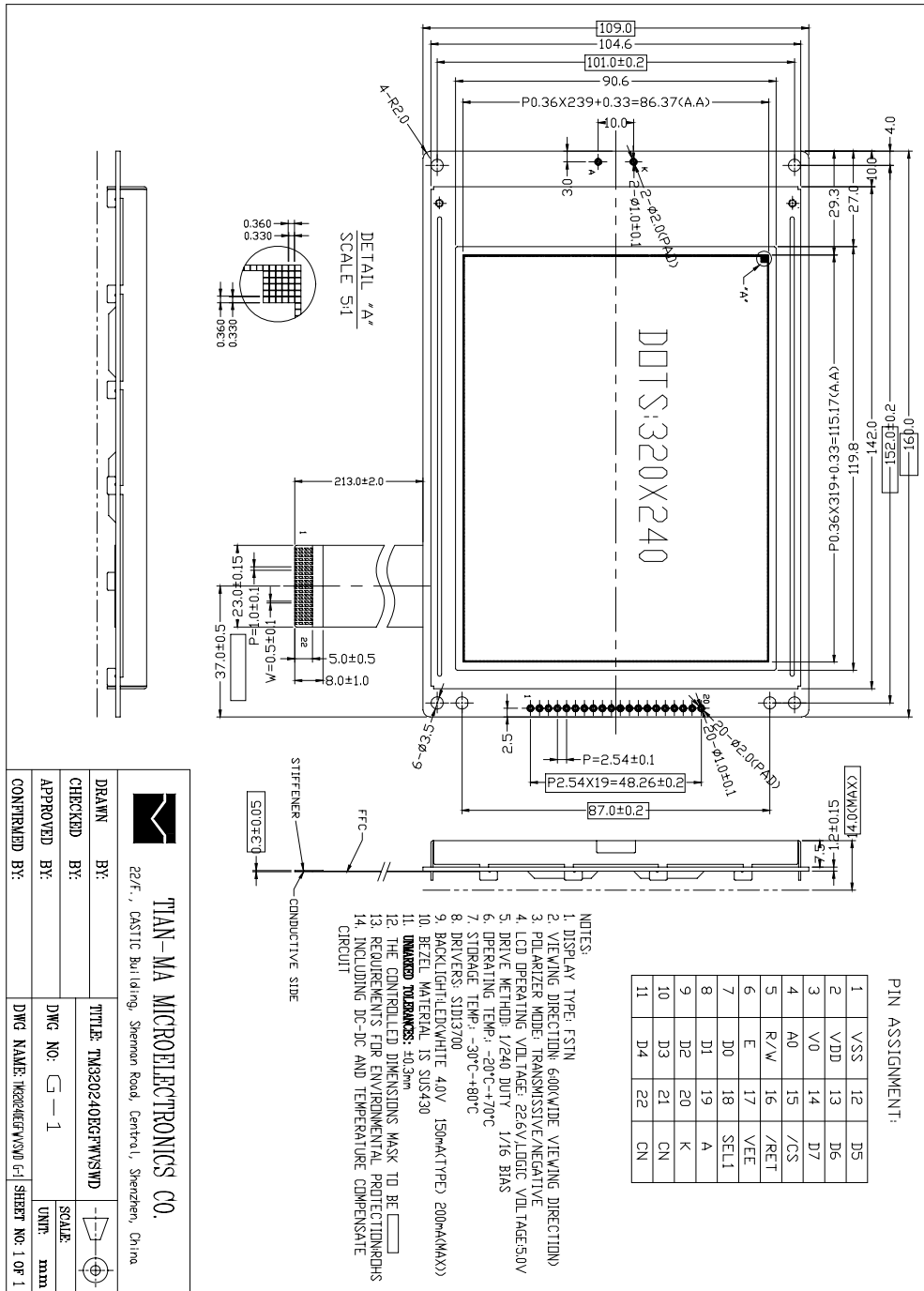

5 Circuit

5.1 Block Diagram

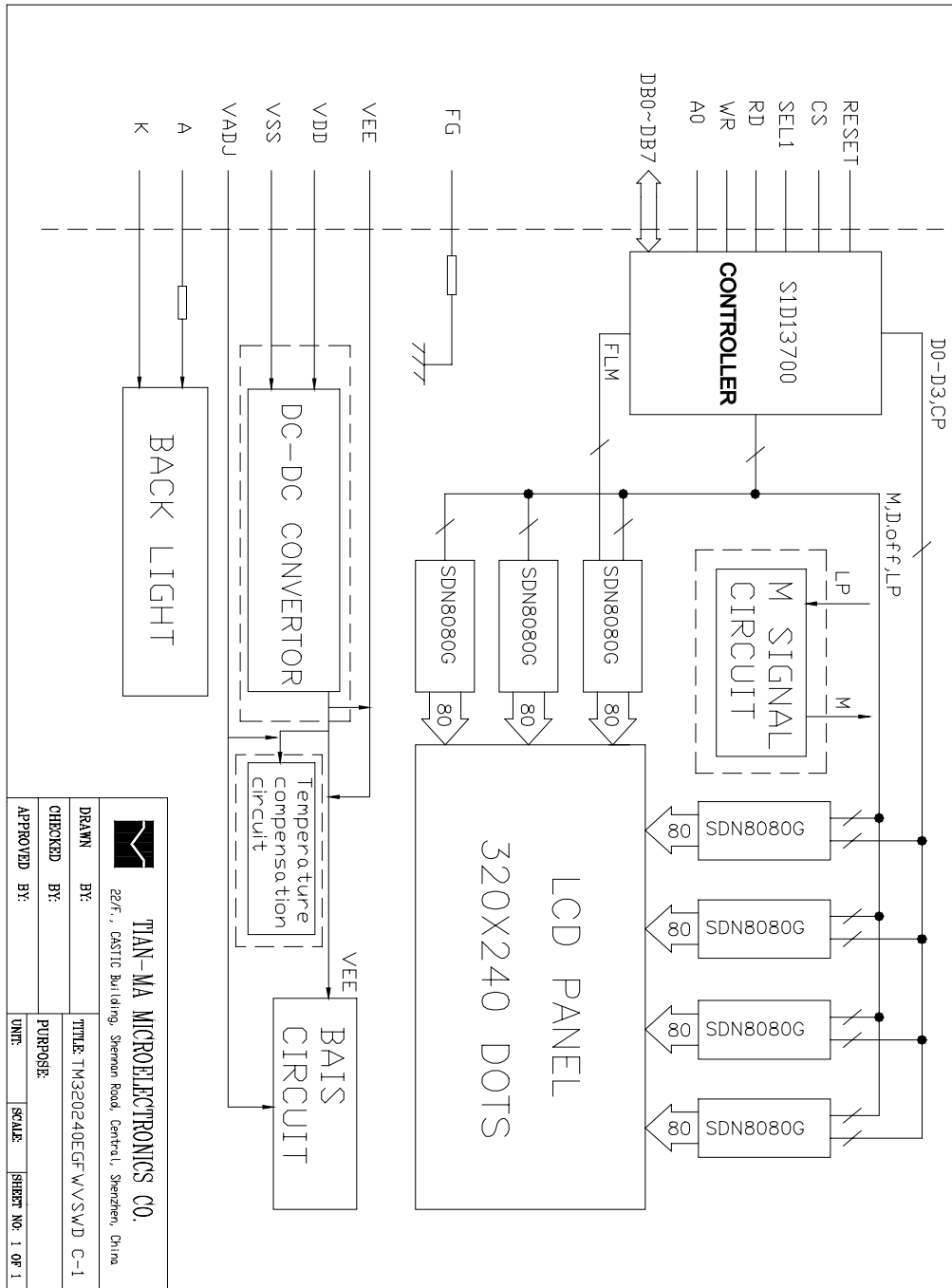

5.2 Recommend power supply circuit

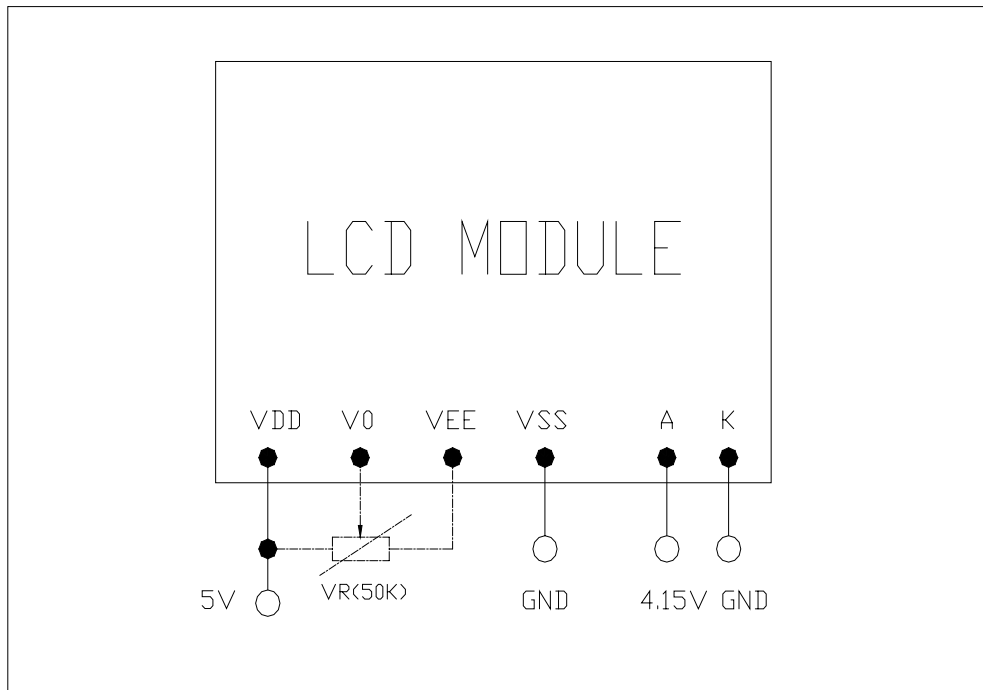

Note [5-1]: If you needn't DC-DC circuit and want to input negative power supply by VEE directly, please remove R28/R29 on the PCB first.

Note [5-2]: If you want to control the contrast outside, please add the VR and its circuit.

6 Interface description

Pin No.	Symbol	I/O	Description
1	V _{SS}	I	Ground
2	V _{DD}	I	Power supply voltage for logic circuits and LCD(+5V)
3	V ₀	--	V _{OP} adjust control pin, refer to Note [5-2]
4	A0	H/L	H : D0~D7 are Display Data L : D0~D7 are Instructions
5	R/W	I	80 family CPU : Write Signal L : Active
6	E	I	80 family CPU : Read Signal L : Active
7	D0	I/O	Data bus bit0(LSB)
8	D1	I/O	Data bus bit1
9	D2	I/O	Data bus bit2
10	D3	I/O	Data bus bit3
11	D4	I/O	Data bus bit4
12	D5	I/O	Data bus bit5
13	D6	I/O	Data bus bit6
14	D7	I/O	Data bus bit7(MSB)
15	/CS	I	Chip enable signal for S1D13700. Low active
16	/RET	I	Reset execution control pin
17	VEE	I/O	The output voltage of DC/DC converter for LCD(-), or the Input for V _{EE}
18	SEL1	I	Select the host bus interface. (H:6800 series L:8080 series)
19	A	I	Power supply voltage for LED(+),4.0V or 150mA.
20	K	I	Power supply voltage for LED(-)
21	NC	-	No connection
22	NC	-	No connection

7 Instruction Code & Timing characteristics

7.1 Command and initial code

The module TM320240EGFWVSWD includes the controller-S1D13700. Selecting indirect mode for the system interface, users can use commands to set up the display. The table below lists the types of commands, including the code of each command. More details please refer to data sheet of S1D13700.

Purpose	Command	Code				Command description	No. of para.	Remarks						
		WR/RD/AB0	DB 7	BIN 6	DB 5				BIN 4	DB 3	BIN 2	DB 1	HEX 0	
Operation control	SYSTM SET	1 0 1	0	1	0	0	0	0	0	0	40	Sets initial operation and window size.	8	
	SLEEP IN	1 0 1	0	1	0	1	0	0	1	1	53	Sleep operation.	0	Note
Display control	DISPON/OFF	1 0 1	0	1	0	1	1	0	0	D	58 • 59	Instructs to turn display on or off and make the screen flash on and off.	1	Note
	SCROLL	1 0 1	0	1	0	0	0	1	0	0	44	Sets the display start address and display area.	10	
	CSRFORM	1 0 1	0	1	0	1	1	1	0	1	5D	Sets the cursor shape, etc.	2	
	CSRDIR	1 0 1	0	1	0	0	1	1	1	0	4C – 4F	Sets the direction of cursor movement.	0	
	OVLAY	1 0 1	0	1	0	1	1	0	1	1	5B	Instructs screen overlay mode.	1	
	CGRAM ADR	1 0 1	0	1	0	1	1	1	0	0	5C	Sets the start address of CG RAM.	2	
	HDOT SCR	1 0 1	0	1	0	1	1	0	1	0	5A	Sets the horizontal direction dot unit and scroll position.	1	
	GRAY SCALE	1 0 1	0	1	1	0	0	0	0	0	60	Sets grayscale mode.	0	
	Drawing control	CSRW	1 0 1	0	1	0	0	0	1	1	0	46	Sets the cursor address.	2
CSRR		1 0 1	0	1	0	0	0	1	1	1	47	Instructs to read the cursor address.	2	Note
Memory control	MWRITE	1 0 1	0	1	0	0	0	0	1	0	42	Instructs to write to display memory.	—	Note
	MREAD	1 0 1	0	1	0	0	0	0	1	1	43	Instructs to read display memory data.	—	

Every command is executed after the parameters of the command are input to the S1D13700, and completed before the next parameter (P) or command (C) is input. The MPU can also stop sending parameters and send the next command. In this case, the parameters that have already been sent are effective and other parameters not input to the S1D13700 retain their original values. However, two-byte parameters are handled as described below.

Note :

- CSRW and CSRR commands: The parameter is executed one byte at a time. Therefore, the MPU can only alter or check the low-order byte.
- Commands except CSRW and CSRR: The parameter is not executed until its second byte is input
SYSTEM SET SCROLL CGRAM ADR
- Two-byte parameters consist of two bytes of data (as in the case of APL and APH).
- Because the value of each register after power-on is indeterminate, make sure all command parameters are set.

7.2 Interface Timing characteristics

Please refer to S1D13700's datasheet for more details.

Generic Bus Direct/Indirect Interface without WAIT# Timing.

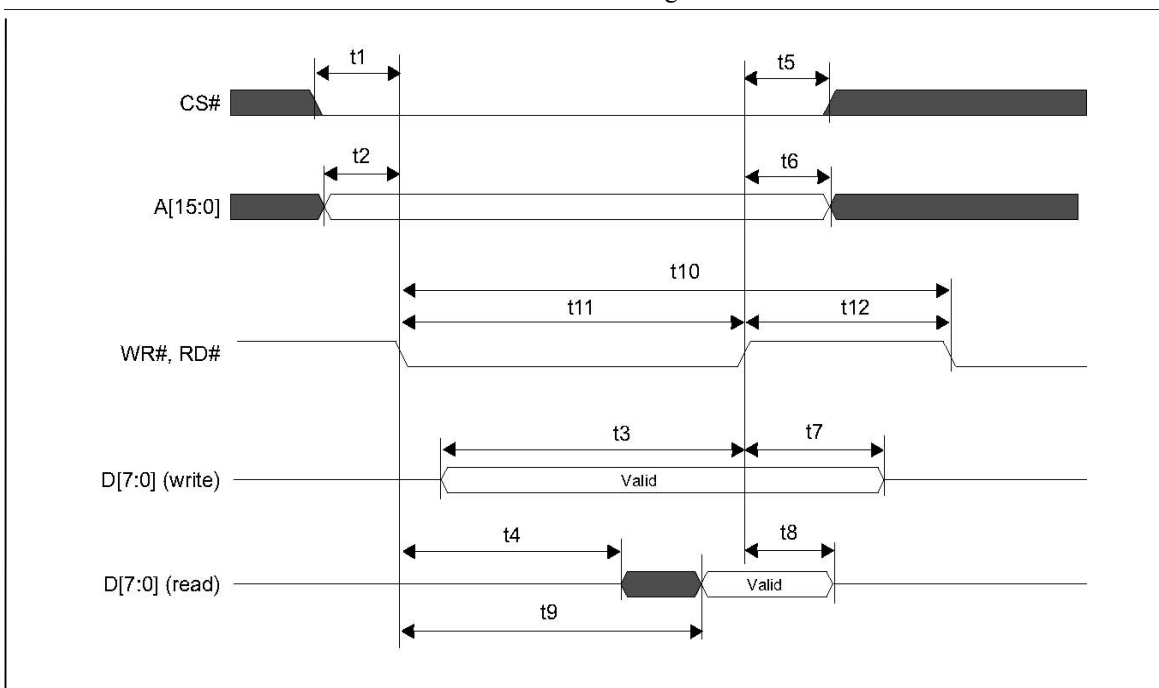

Symbol	Parameter	Min	Max	Units
t1	CS# setup time	5	--	ns
t2	A[15:0] setup time	5	--	ns
t3	D[7:0] setup time to WR# rising edge (write cycle)	Note 2	--	ns
t4	RD# falling edge to D[7:0] driven (read cycle)	3	--	ns
t5	CS# hold time	7	--	ns
t6	A[15:0] hold time	7	--	ns
t7	D[7:0] hold time from WR# rising edge (write cycle)	5	--	ns
t8	D[7:0] hold time from RD# rising edge (read cycle)	3	14	ns
t9	RD# falling edge to valid Data (read cycle)	--	Note 3	ns
t10	RD#, WR# cycle time	Note 4	--	ns
t11	RD#, WR# pulse active time	5	--	Ts
t12	RD#, WR# pulse inactive time	Note 5	--	ns

Note:

- 1 Ts = System clock period
- 2 t3min = 2Ts + 5
- 3 t9max = 4Ts + 20 (for 5.0V)
- 4 t10min = 6Ts (for a read cycle followed by a read or write cycle)
= 7Ts + 2 (for a write cycle followed by a write cycle)
= 10Ts + 2 (for a write cycle followed by a read cycle)
- 5 t12min = 1Ts (for a read cycle followed by a read or write cycle)
= 2Ts + 2 (for a write cycle followed by a write cycle)
= 5Ts + 2 (for a write cycle followed by a read cycle)

7.3 Character generator code map

		Character code bits 0 to 3															
		0	1	2	3	4	5	6	7	8	9	A	B	C	D	E	F
Character code bits 4 to 7	2		!	"	#	\$	%	&	'	()	*	+	,	-	.	/
	3	0	1	2	3	4	5	6	7	8	9	:	<	=	>	?	
	4	a	b	c	d	e	f	g	h	i	j	k	l	m	n	o	
	5	P	O	R	S	T	U	V	W	X	Y	Z	[]	^	_	
	6	"	a	b	c	d	e	f	g	h	i	j	k	l	m	n	o
	7	P	Q	R	S	T	U	V	W	X	Y	Z	[]	^	_	
	A		a	b	c	d	e	f	g	h	i	j	k	l	m	n	o
	B		a	b	c	d	e	f	g	h	i	j	k	l	m	n	o
	C		a	b	c	d	e	f	g	h	i	j	k	l	m	n	o
	D		a	b	c	d	e	f	g	h	i	j	k	l	m	n	o
1																	

8 Electrical characteristics

Parameter	Symbol	Condition	MIN	TYP	MAX	UNIT
Logic circuit supply voltage	V_{DD}	--	4.8	5.0	5.2	V
Power supply LCD(-)	V_{EE}			-23		
Input voltage for logic circuit	“H” level	V_{IH}	$0.8 V_{DD}$	V_{DD}	$V_{DD} + 0.3$	
	“L” level	V_{IL}	$V_{SS} - 0.3$	V_{SS}	$0.2V_{DD}$	
Output voltage for logic circuit	“H” level	V_{OH}	--	V_{DD}	--	
	“L” level	V_{OL}	--	V_{SS}	--	
Logic power supply current (Without backlighting)	I_{DD}	$V_{DD}=5.0V$	--	TBD	--	mA
Used driver IC	S1D13700(Controller)+SDN8080(COM/SEG Driver)					

9 LED backlight characteristics

CIRCUIT DIAGRAM(1X10 LED'S)

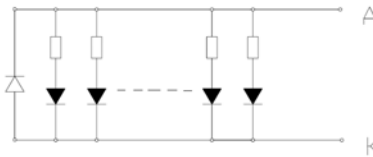

Item	Symbol	Condition	MIN.	TYP.	MAX.	Unit	Remark
Forward voltage	V_f	$I_f=150mA$	---	4.0	---	V	---
Forward current	I_f	$V_f=4.0V$	--	150	200	mA	---
Lifetime	t	--	--	TBD	--	hours	Note [9-1,2]

Note [9-1]: If the backlight is used above its' driving voltage or current for a long time, its lifetime will reduce or it will cause poor reliability.

Note [9-2]: The backlight lifetime lasts until the luminance reduces to 50% of its initial value.

10 Optical Characteristics

1/240Duty, 1/16Bias (Note [10-2]), $f=70\text{Hz}$

Parameter	Symbol	Ratings			Unit	Measuring Temp.	Remark	
		Min	Type	Max.				
Contrast ratio	Cr ($\theta=0^\circ, \Phi=0^\circ$)	---	8	---	---	25□	Note[10-1,3]	
Response time	Turn on	t_{on}	---	200	---	ms	25□	Note[10-1,4]
			---	TBD	---		0□	
	Turn off	t_{off}	---	160	---	ms	25□	
			---	TBD	---		0□	
Viewing angle (Cr \geq 3)	Up-down	θ_1 ($\Phi=0^\circ$)	---	+20	---	deg	25□	Note[10-1,5]
			---	-15	---			
	Left-right	θ_2 ($\theta=0^\circ$)	---	+20	---	deg	25□	
			---	-15	---			
Luminance	Y_L ($\theta=0^\circ, \Phi=0^\circ$)	---	60	---	Cd/m ²	25□	Note[10-1] ($I_f=150\text{mA}$)	
Luminance Uniformity	L_U ($\theta=0^\circ, \Phi=0^\circ$)	70	---	---	%	25□	Note[10-1,6]	

Note [10-1]: Measuring equipments: DMS-501, PR-705.

Measuring condition:

- After stabilizing and leaving the panel alone at a given temperature for 30 min, the measurement should be executed,
- Measuring surroundings: a stable, windless and dark room,
- Measuring temperature: $T_a=25^\circ\text{C}$,
- 30 min after lighting the back-light.

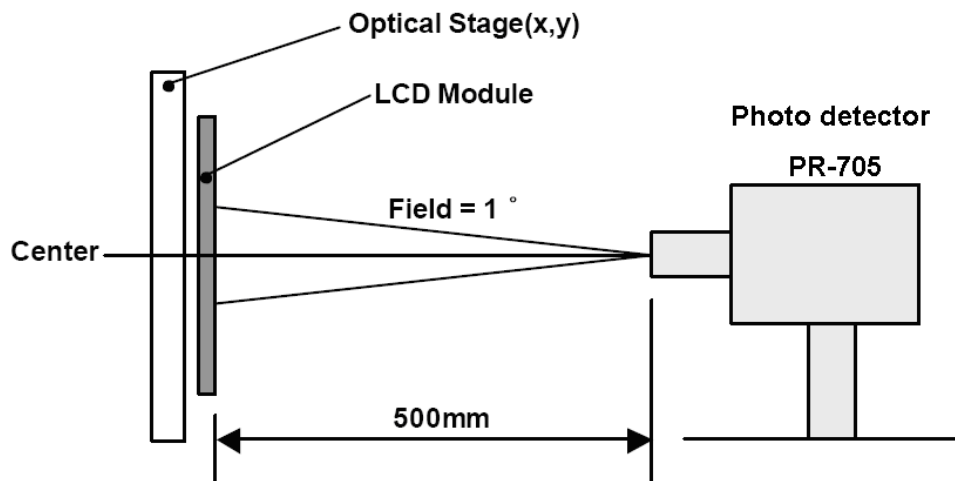

Note [10-2]: The maximum and minimum ratings don't mean the LCD works well in the whole range of V_0 . V_0 must be adjusted to optimize the viewing angle and contrast. Refer to the following definition of drive voltage:

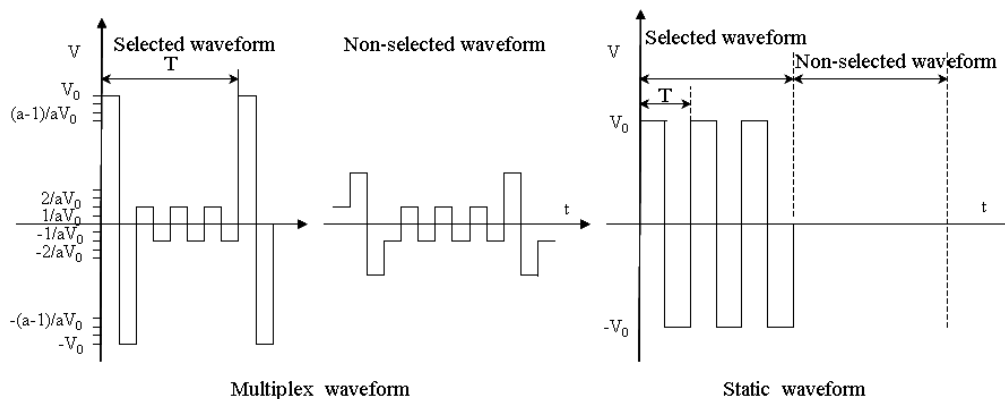

Operating voltage: V_0	Frame frequency: $f=1/T$
Duty: $1/N$	Bias: $1/a$

Note [10-3]: Contrast ratio(CR) is defined as follows:

$$CR = \frac{L_{ON} \text{ (Luminance of the ON segments)}}{L_{OFF} \text{ (Luminance of the OFF segments)}}$$

Note [10-4]: Definition of response time:

Turn on time (rise time): $t_{on} = t_d + t_r$ (The time that the luminance level reaches 90% of the saturation level from 0% when ON signal is applied)

Turn off time (fall time): $t_{off} = t_d + t_r$ (The time that the luminance level reaches 10% of the saturation level from 100% when OFF signal is applied)

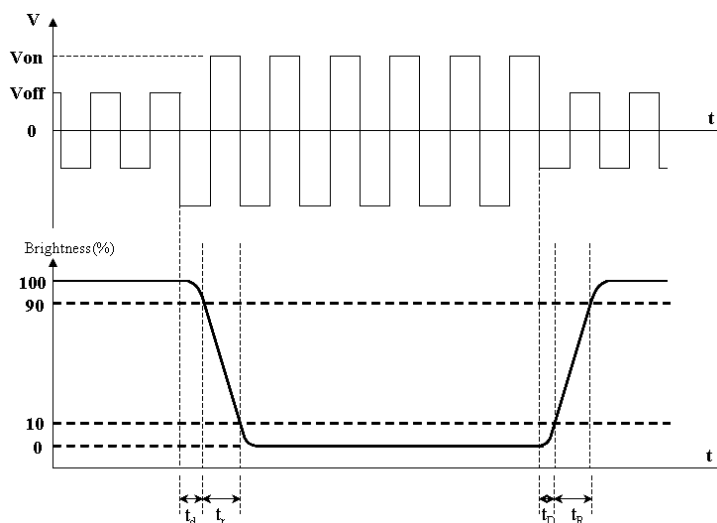

Note [10-5]: Definition of viewing direction

Refer to the picture below marked by θ and Φ

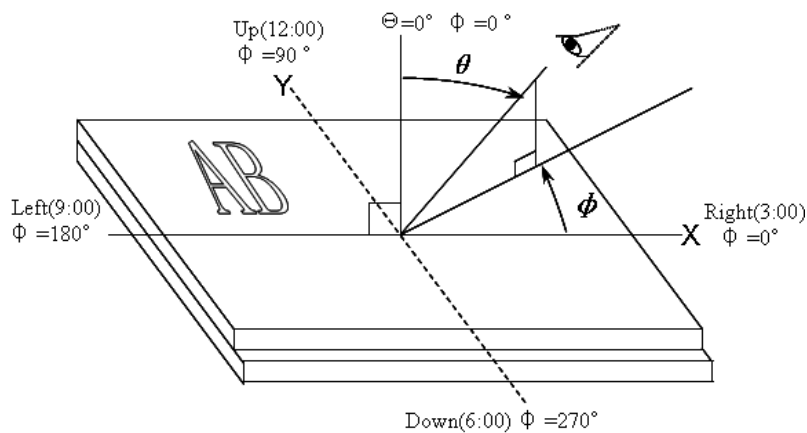

Definition of viewing angle

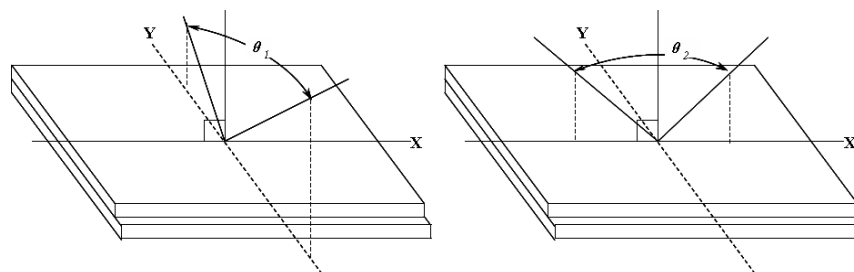

θ_1 ——range of viewing angle from up to down; θ_2 ——range of viewing angle from left to right.

Note [10-6]: The definition of luminance uniformity:

The luminance uniformity is calculated by using following formula.

$$\text{Luminance uniformity (Lu)} = \frac{\text{Minimum luminance from } \square \text{ to } \square}{\text{Maximum luminance from } \square \text{ to } \square}$$

The luminance is measured at near the 9 points shown below.

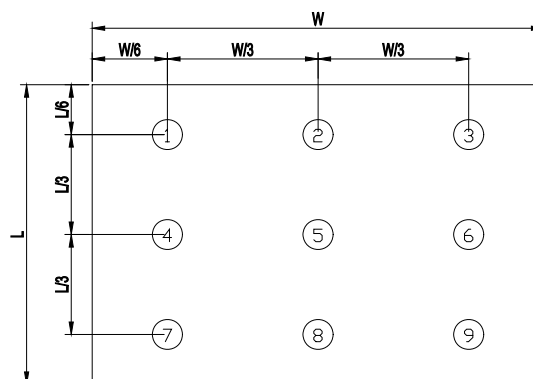

11 Reliability

11.1 Content of Reliability Test

No.	Test Item	Test condition	Remark	Criterion
1	High Temperature Storage	Ta=80□, 120H		Remark1 Remark2 Remake3 Remake4
2	Low Temperature Storage	Ta=-30□, 120H	Note[11-1]	
3	High Temperature Operation	Ta=70□, 120H		
4	Low Temperature Operation	Ta=-20□, 120H	Note[11-1]	
5	High Temperature & High Humidity Operation	Ta=60□,90%RH,120H	Note[11-1]	
6	Temperature Cycle Test (Non-Operating)	-30 °C↔+25 °C↔+80 °C,100 Cycles 30min 5min 30min	Note[11-1]	
7	Vibration Test	Frequency: 10 ~150 Hz, Stroke: 1.5mm Sweep time: 11 min Test Period: 6 Cycles for each direction of X,Y,Z,120 min every direction	Note[11-2]	Remark1 Remark5 Remark6
8	Shock Test	Waveform : Half Sinusoidal Wave Shock Level:50 G, Pulse Width:11 ms, Direction: ±X, ±Y, ±Z, Cycle:3 times	Note[11-2]	

Note [11-1]: No dew condensation to be observed.

Note [11-2]: Vibration test will be conducted to the product itself without putting it in a container.

Note [11-3]: The test sample is inspected after 2 hours or more storing at room temperature and room humidity after each test item is finished.

Note[11-4]:T he criteria refer to 11.2.

11.2 Inspection of criteria

Remark NO.	Content
1	Function test is OK. Missing Segment, shorts, unclear segment, non-display, display abnormally, liquid crystal leak are unallowable.
2	After testing, cosmetic defects should not happen, no low temperature bubbles, seal loose and fall, frame rainbow, ACF bubble growing are unallowable in the appearance test.
3	Total current consumption should not be over 10% of initial value.
4	After tests, the contrast ratio must be larger than 70% of its value before.
5	No glass crack, chipped glass, end seal loose frame crack and so on.
6	No structure looseness.

12 Package

TBD

13 Quality level

Examination or Test	At T _a =25 (Unless otherwise stated)	Inspection				
		Min	Max	Unit	IL	AQL
External Visual Inspection	Under normal illumination and eyesight condition, the distance between eyes and LCD is 25cm.	Refer to appendix A			II	Major 1.0 Minor 2.5
Display Defects	Under normal illumination and eyesight condition, display on inspection.	Refer to appendix B			II	Major 1.0 Minor 2.5
Note: Major defects: Open segment or common, Short, Serious damages, Leakage Miner defects: Others Sampling standard conforms to GB2828						

14 Precautions for Use of LCD Modules

14.1 Handling Precautions

- 14.1.1 The display panel is made of glass. Do not subject it to a mechanical shock by dropping it from a high place, etc.
- 14.1.2 Liquid in LCD is hazardous substance, if the display panel is damaged and the liquid crystal substance inside it leaks out, be sure not to get any in your mouth, if the substance comes into contact with your skin or clothes, thoroughly and promptly wash it off using soap and water.
- 14.1.3 Do not apply excessive force to the display surface or the adjoining areas since this may cause the color tone to vary.
- 14.1.4 Don't touch, push or rub the exposed polarizer covering the display surface of the LCD module with anything harder than an HB pencil lead, the polarizer is soft and easily scratched, handle it carefully.
- 14.1.5 Don't put or attach anything on the display area to avoid leaving any marks on.
- 14.1.6 If the display surface is contaminated or becomes dusty, breathe on the surface and gently wipe it with a soft dry cloth. do not scrub hard to avoid damage the surface. If still not completely clear, moisten cloth with one of the following solvents:
- Isopropyl alcohol
 - Ethyl alcohol
- Solvents other than those mentioned above may damage the polarizer. Especially, do not use the following:
- Water
 - Ketone
 - Aromatic solvents
- 14.1.7 Do not attempt to disassemble the LCD Module.
- 14.1.8 If the logic circuit power is off, do not apply the input signals.
- 14.1.9 Avoid using the same display pattern long time (continuous ON segment).Software must be prepared so that the pattern will be changed

- 14.1.10 To prevent destruction of the elements by static electricity, be careful to maintain an optimum work environment.
- Be sure to ground the body and electric appliances when handling the LCD Modules. It is preferable to use conductive mat on table and wear cotton clothes or conductive processed fibre. Synthetic fibre is not recommended.
 - Tools required for assembly, such as soldering irons, must be properly ground.
 - To reduce the amount of static electricity generated, do not conduct assembly and other work under dry conditions.
 - The LCD Module is coated with a film to protect the display surface. Be careful and slow when peeling off this protective film since static electricity may be generated. It is recommended to use ionic fan or machine when operating. It is recommended to remove the protection foil slowly (> 3 sec.).
 - It is preferable to wear gloves etc, to avoid damaging the LCD. Please do not touch electrodes with bare hands or avoid any other contamination.

14.2 Storage precautions

- 14.2.1 When storing the LCD modules, avoid exposure to direct sunlight or to the light of fluorescent lamps.
- 14.2.2 The LCD modules should be stored under the storage temperature range. If the LCD modules will be stored for a long time, the recommend condition is:
- Temperature : 5℃ ~ 40℃
- Relatively humidity: ≤80%
- 14.2.3 The LCD modules should be stored in a clean environment or room, free from acid, alkali and harmful gas.
- 14.2.4 Store the module in anti-static electricity container and without any physical load.

14.3 Transportation precautions

The LCD modules should be no falling and violent shocking during transportation, and also should avoid excessive press, water, damp and sunshine.

14.4 Soldering

- 14.4.1 Use the high quality solders, only solder the I/O terminals.
- 14.4.2 No higher than 280℃ and time less than 3-4 second during soldering.
- 14.4.3 Rewiring: no more than 3 times.
- 14.4.4 when you remove connector or cable soldered to I/O terminals, please confirm that solder is fully melted. If you remove by force, electrodes at I/O terminals may be damaged (or stripped off). It is recommended to use solder suction machine.

15. LCD Module Part Numbering System

TM	320240	E	G	F	W	V	S	W	D
-----------	---------------	----------	----------	----------	----------	----------	----------	----------	----------

NO.	Explanation	
①	TIANMA module indicating	
②	Module type: 320 columns X 240 rows, 6 DIGITS	
③	TIANMA module series	
④	LCD type	
	G	Negative, FSTN
⑤	Backlight type	
	F	Transmissive, LED
⑥	Temperature range	
	W	Wide temperature
⑦	Viewing Angle	
	V	Wide viewing direction
⑧	Technology	
	S	SMT (only SMT)
⑨	The color of backlight	
	W	White
⑩	Function choice	
	D	Including DC-DC and Temp. Compensate circuit

Appendix A
Inspection items and criteria for appearance defects

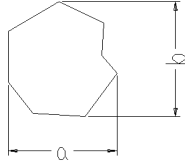
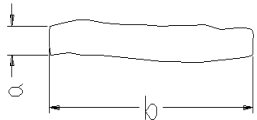
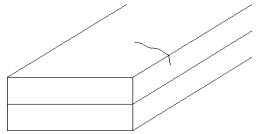
Items	Contents	Criteria		
Protective Glue		No clear defects		
Cover Tape		Covering all of the chip and no clear crimple		
Leakage		Not permitted		
Rainbow		According to the limit specimen		
Polarizer	Wrong polarizer attachment	Not permitted		
	Bubble between polarizer and glass	Not counted	Max. 3 defects allowed	
		$\phi < 0.3\text{mm}$	$0.3\text{mm} \leq \phi \leq 0.5\text{mm}$	
Scratches of polarizer	According to the limit specimen			
Black spot (in viewing area)		Not counted	Max. 3 spots allowed	Max. 3 spots (lines) allowed
		$X < 0.20\text{mm}$	$0.20\text{mm} \leq X \leq 0.5\text{mm}$	
		$X = (a+b)/2$		
Black line (in viewing area)		Not counted	Max. 3 lines allowed	Max. 3 spots (lines) allowed
		$a < 0.02\text{mm}$	$0.02\text{mm} \leq a \leq 0.05\text{mm}$ $b \leq 2.0\text{mm}$	
Progressive cracks		Not permitted		

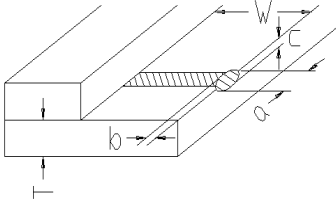
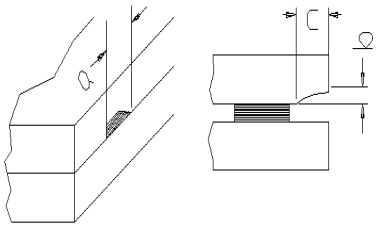
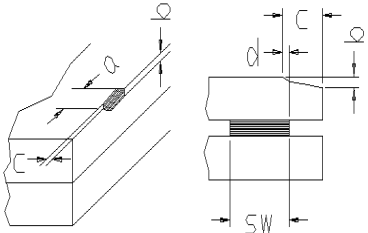
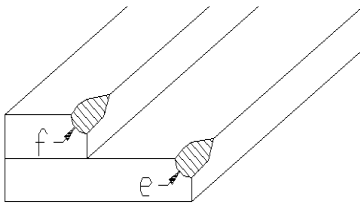
Item	Contents	Criteria							
Glass Cracks	Cracks on pads 	a	b	c	Max. 2 Cracks allowed	Max. 5 cracks allowed			
		$\leq 3\text{mm}$	$\leq W/5$	$\leq T/2$					
		$\leq 2\text{mm}$	$\leq W/5$	$T/2 < C < T$					
	Cracks on contact side 	a	b		Max. 2 cracks allowed				
		$\leq 3\text{mm}$	$\leq T/2$						
		$\leq 2\text{mm}$	$T/2 < b < T$						
		C shall be not reach the seal area							
	Cracks on non-contact side 	a	b		Max. 2 cracks allowed				
		$\leq 3\text{mm}$	$\leq T/2$						
		$\leq 2\text{mm}$	$T/2 < b < T$						
	$C \leq 0.5\text{mm}$								
	$d \leq SW/3$								
Corner cracks 	$e < 2.0\text{mm}^2$ $f < 2.0\text{mm}^2$			Max. 3 cracks allowed					

Appendix B
Inspection items and criteria for display defects

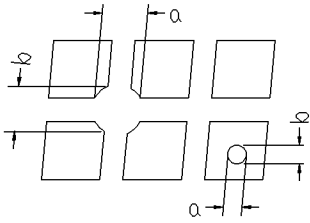
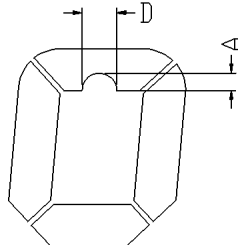
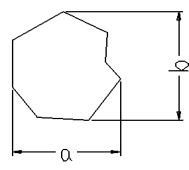
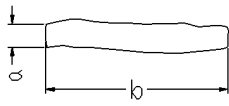
Items	Contents	Criteria		
Open segment or open common		Not permitted		
Short		Not permitted		
Wrong viewing angle		Not permitted		
Contrast ratio uneven		According to the limit specimen		
Crosstalk		According to the limit specimen		
Pin holes and cracks in segment (DOT)		Not counted	Max.3 dots allowed	Max.3 dots allowed
		$X < 0.1\text{mm}$	$0.1\text{mm} \leq X \leq 0.2\text{mm}$	
		$X = (a+b)/2$		
		Not counted	Max.2 dots allowed	
$A < 0.1\text{mm}$ $D < 0.25\text{mm}$				
Black spot (in viewing area)		Not counted	Max.3 spots allowed	Max.3 spots (lines) allowed
		$X < 0.1\text{mm}$	$0.1\text{mm} \leq X \leq 0.2\text{mm}$	
		$X = (a+b)/2$		
Black line (in viewing area)		Not counted	Max.3 lines allowed	
		$a < 0.02\text{mm}$	$0.02\text{mm} \leq a \leq 0.05\text{mm}$ $b \leq 0.5\text{mm}$	

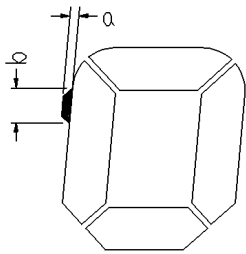
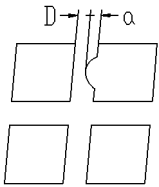
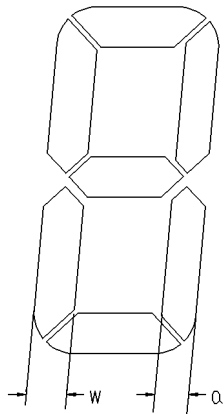
Items	Content	Criteria		
Transformation of segment		Not counted	Max. 2 defects allowed	Max.3 defects allowed
		$x < 0.1\text{mm}$	$0.1\text{mm} \leq x \leq 0.2\text{mm}$	
		$x = (a+b)/2$		
		Not counted	Max. 1 defects allowed	
		$a < 0.1\text{mm}$	$0.1\text{mm} \leq a \leq 0.2\text{mm}$ $D > 0$	
		Max.2 defects allowed $0.8W \leq a \leq 1.2W$ a = measured value of width W = nominal value of width		